

Third-Generation RDMS™ Rackmount Receivers

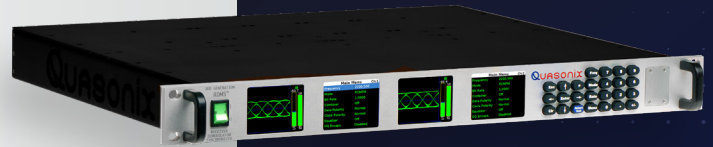

The Final Word on Data Integrity

The highest-performing telemetry receiver on the market is available in an elegant, compact 1U rackmount package and a 3U package with dual, 7-inch full-color touchscreens. Experience the industry's fastest synchronization, best SOQPSK-TG detection, premier Best-Channel Selector and Adaptive Equalizer, and much more - all in an easy-to-use and highly configurable package. Quasonix is... Reinventing Telemetry™.

Complete Receiver - RF to Bits – A single-box solution that includes downconversion, demodulation, and bit synchronization.

Space-Time Coding (STC) with SOQPSK Mode – Space-Time Coding (STC) operates with Quasonix STC-enabled transmitters to eliminate the dropouts caused by transmit antenna pattern nulls due to inter-antenna interference.

Low-Density Parity Check (LDPC) Coding with SOQPSK Mode – Low-Density Parity Check coding operates with Quasonix LDPC-enabled transmitters to improve link margin by up to 9 dB, while still using 22% less bandwidth than PCM/FM at the same payload data rate.

Data Quality Encapsulation (DQE) and Data Quality Metric (DQM) – Data Quality Encapsulation (DQE) is a process of bundling Data Quality Metric words with payload data, including a sync word to aid BSS time alignment; built-in real-time DQM display.

Best-Channel Selector (BCS) – Combiner data output seamlessly selects the best channel (Channel 1, Channel 2, or Pre-Detection Diversity Combiner) based on DQM.

Built-In Integrated Three-Channel Spectrum Analyzer – Spectrum analyzer shows frequency domain view for up to three channels simultaneously.

Optional Adaptive Equalizer – Powerful decision-directed equalizer mitigates multipath distortion.

Pre-Detection Multi-Mode Diversity Combiner – Provides Maximal Ratio Combining with gain virtually indistinguishable from theory. Also features a revolutionary dynamic time alignment function which increases the allowable time skew between channels by over 1300 nanoseconds—more than 60 bits at high bit rates!

Built-In Playback Demodulator – IF Inputs for each channel, 75 kHz to 20 MHz, or 70 MHz with selectable SAW filter.

Simultaneous RS-422 and TTL Outputs with All Units – One RDMS does it all—no need to order separate output options.

Tuning Range from 200 MHz to 5250 MHz – Optional contiguous tuning from 200 MHz through 2500 MHz and 4400 MHz through 5250 MHz.

Versatile Rackmount Enclosures – Legacy 1U or 3U 19" rack-mount chassis houses one or two receiver channels covering P, lower L, upper L, full S, C, or multiple bands per channel.

Easy Field Updates – Software and firmware updates - free for the lifetime of your receiver - can now be installed by the customer on site.

Future-Proofing Simplified – Upgrades such as new DSP and GUI features can be added with a simple file download while your receiver is still in the rack.

Best SOQPSK-TG Detection in the Industry – RDMS's trellis detection for SOQPSK-TG yields improvements of 2 dB or more over the competition's single-symbol detectors.

True Trellis Demodulation in All ARTM Modes – Provides true multi-symbol trellis detection in all three ARTM modes for optimal demodulation.

3.5 to 5 dB Improvement in PCM/FM Performance – Improves BER performance by 3.5 to 5 dB over the best single-symbol demodulators, to within 0.2 dB of the theoretical limit.

Enhanced Modulation Index Tracking* for PCM/FM – Maintains superior BER performance even if the received signal's modulation index varies by as much as 500%, a major breakthrough for tracking legacy analog transmitters (*patented).

Automatic Phase Noise Compensation – Optimizes demodulator performance for use with legacy TM packs and transmitters with excessive phase noise; can engage automatically, when needed, to provide optimal performance.

Lowest Noise Figure – Typical 3.5 dB noise figure bests all other ARTM receivers on the market, hands down.

Rapid Synchronization – Synchronizes up to 100 times faster – and maintains sync at lower signal-to-noise ratios – than any other ARTM demodulator.

Combiner OFF—Two Independent Receivers—Two Control Windows

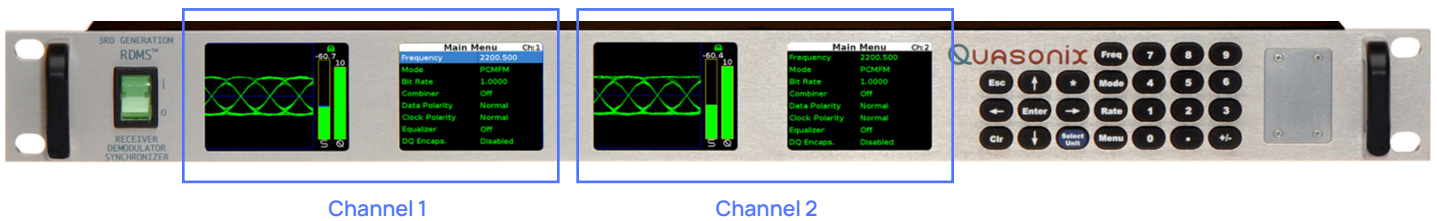

Channel 1

Channel 2

Combiner ON—Single Control Window

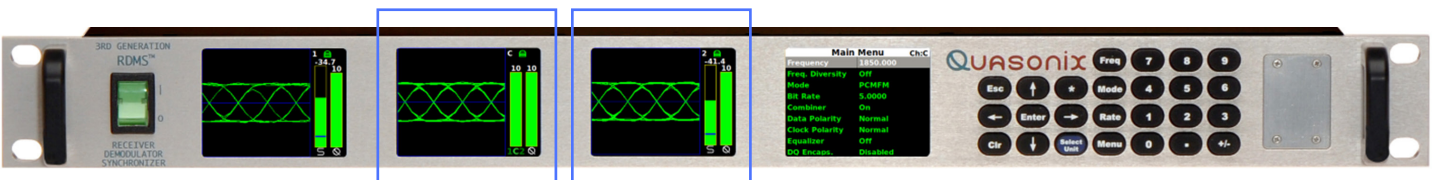

Combiner

Channel 2

70 MHz IF Inputs for each Channel

Combiner I & Q Outputs



Aux Analog Outputs

Combiner IF Output

3U Touchscreen Chassis

You haven't seen a telemetry receiver like this!

Intuitive, Full Color, 7-Inch Touchscreens – Dual 7-inch touchscreens allow the operator to display the appropriate eye pattern or constellation for a particular waveform mode, AND the spectrum image associated with the mode.

More Clock and Data Outputs – Twice as many clock and data outputs as a 1U RDMS.

More Analog Outputs – Additional high speed DAC outputs and auxiliary analog outputs on each channel.

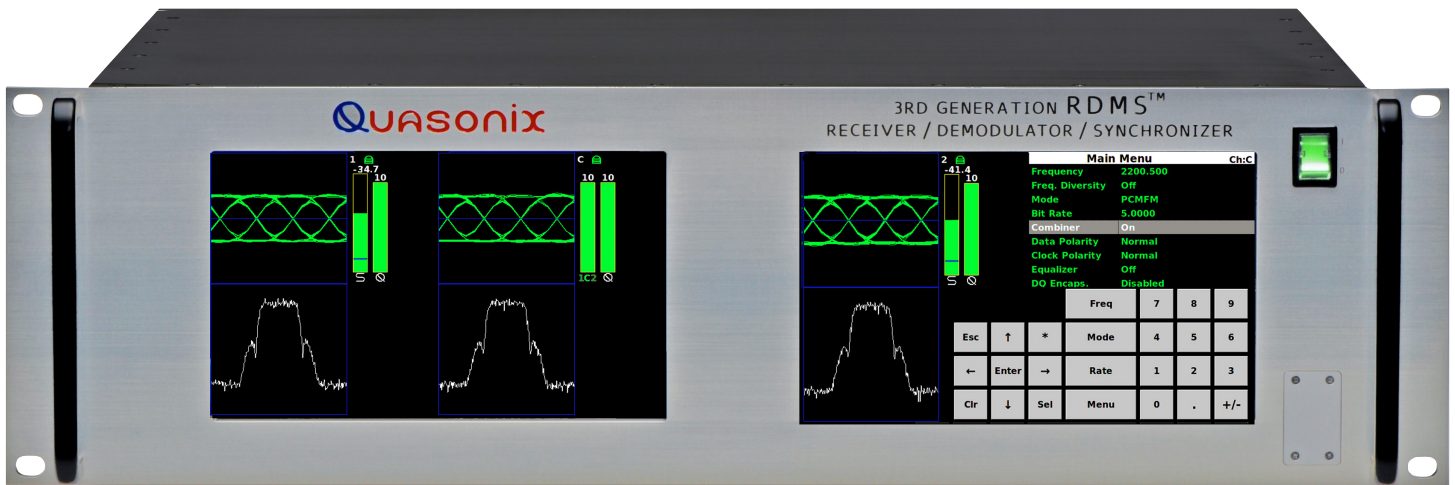

7-Inch Touchscreens

3U Rear Panel



Remote RDMS Client

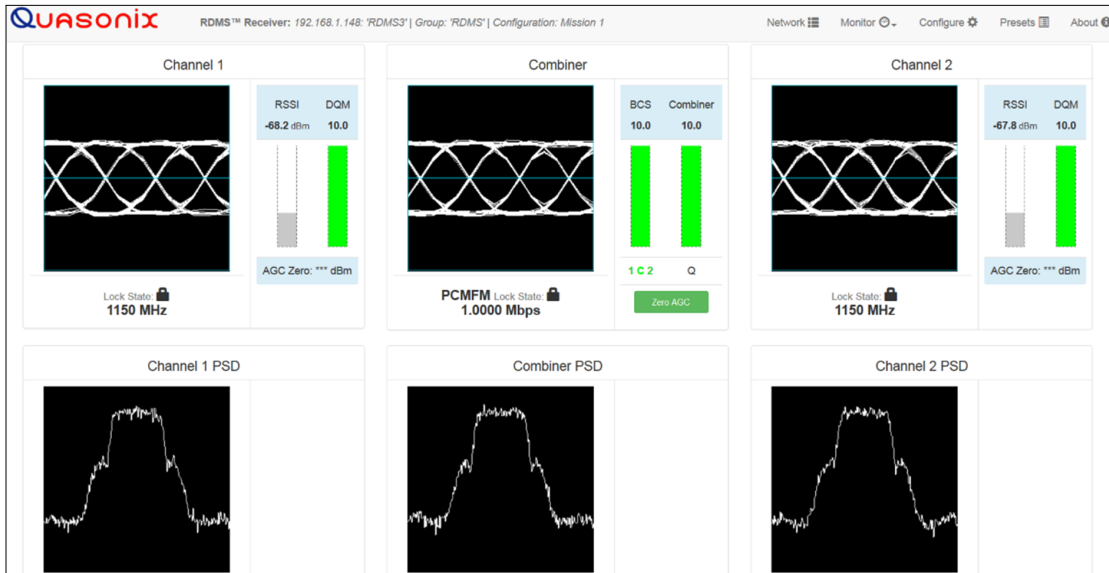

Features

- Browser-based interface—works with common web browsers
- Intuitive layout with all primary control and monitoring functionality for Channel 1, Channel 2, and Combined Channel in one window

The screenshot shows the 'Configure' page for the Remote RDMS Client. It is titled 'Configure: View or Modify Current Receiver Settings'. The interface includes several sections:

- Name:** Antenna 1
- Description:** Mission Description
- Combiner:** Includes checkboxes for 'Combiner' and 'Frequency Diversity'.
- System Settings:** A list of expandable sections: Antenna Controls, Clock/Data Output Controls, and Test Utilities.
- Advanced:** Includes a 'Zero AGC' button, 'RSSI Display: Absolute', 'Reset to Factory Defaults', and 'Shutdown Hardware' buttons.

Buttons for 'Send Settings', 'Save As Preset', and 'Refresh' are located below the description field.

The screenshot displays the 'Network' view of the Remote RDMS Client. It features a table listing the status of various channels. A warning message at the top states: 'All viewed channels are not locked. (Channels shown: 11. Channels not shown: 0.)'

| Show | RDMS Address | Configuration Name | Channel | Frequency (MHz) | Mode | Bit Rate (Mbps) | dBm | DQM | Lock Status | Action |
|-------------------------------------|---------------|--------------------|---------|-----------------|--------|-----------------|---------|-------|-------------|-------------------|
| <input checked="" type="checkbox"/> | 192.168.1.159 | Mission 0 | 1 | 2200.500 | PCFMFM | 1.000000 | -61.13 | 10.00 | Locked | Configure Monitor |
| <input checked="" type="checkbox"/> | | | C | | | | | 10.00 | Locked | |
| <input checked="" type="checkbox"/> | | | 2 | | | | -59.87 | 10.00 | Locked | |
| <input checked="" type="checkbox"/> | 192.168.1.10 | Mission 0 | 1 | 2200.500 | STC | 5.000000 | -82.76 | 8.25 | Locked | Configure Monitor |
| <input checked="" type="checkbox"/> | | | C | | | | | 9.33 | Locked | |
| <input checked="" type="checkbox"/> | | | 2 | | | | -81.98 | 7.88 | Locked | |
| <input checked="" type="checkbox"/> | 192.168.1.172 | Mission 0 | 1 | 1800.000 | SOQPSK | 10.000000 | -105.45 | 0.00 | Not Locked | Configure Monitor |
| <input checked="" type="checkbox"/> | | | 2 | | | | -83.94 | 0.00 | Not Locked | |
| <input checked="" type="checkbox"/> | 192.168.1.71 | Mission 0 | 1 | 2211.000 | SOQPSK | 11.000000 | -90.91 | 4.20 | Locked | Configure Monitor |
| <input checked="" type="checkbox"/> | | | C | | | | | 7.65 | Locked | |
| <input checked="" type="checkbox"/> | | | 2 | | | | -90.97 | 4.14 | Locked | |

Buttons for 'Show All' and 'Show Only Combiners' are located at the bottom left of the table.

Adaptive Equalizer Option for RDMS Telemetry Receivers

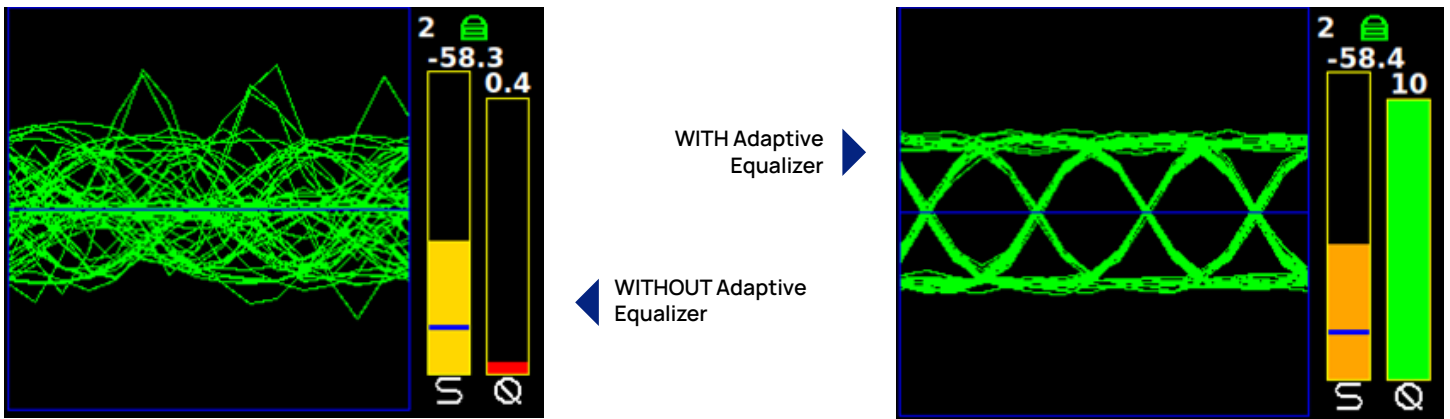

Improves Reception in Multipath Channels

- Adaptive Equalizer combats Multipath Fading with Digital Signal Processing.
- NEW! Uses decision-directed feedback to tackle harsh channels and provide cleaner results.
- Available in Tier 0 (PCM/FM), Tier 1 (SOQPSK-TG), Tier 2 (ARTM CPM/Multi-h CPM), BPSK, QPSK, OQPSK, DPM, and SOQPSK/LDPC modes of operation.
- Works with your existing transmitter, no matter what brand it is.

Available as a programming upgrade to most Quasonix RDMS Telemetry Receivers

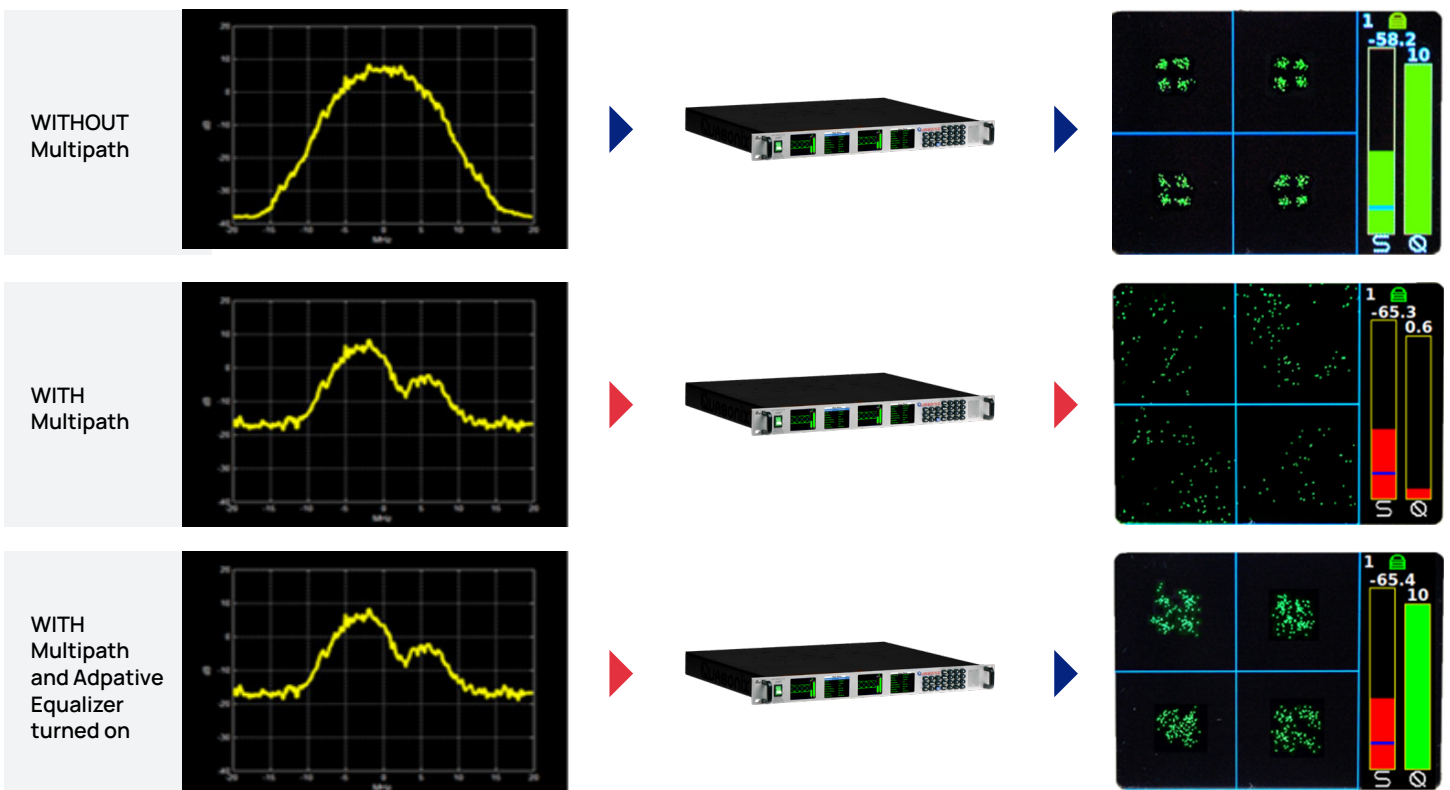

Adaptive Equalizer Solution

Problem: Signal Distortion due to Multipath Fading

- Reflections can add or subtract to create multipath fading
- Cannot be solved with more power

Solution: Reduce Distortion with Adaptive Equalizer

Advantages of the Quasonix Adaptive Equalizer Solution:

Reduces effects of Multipath Fading

- Improves overall link availability

Receiver Configuration

- Compatible with standard telemetry applications and installations
- No training sequences are required

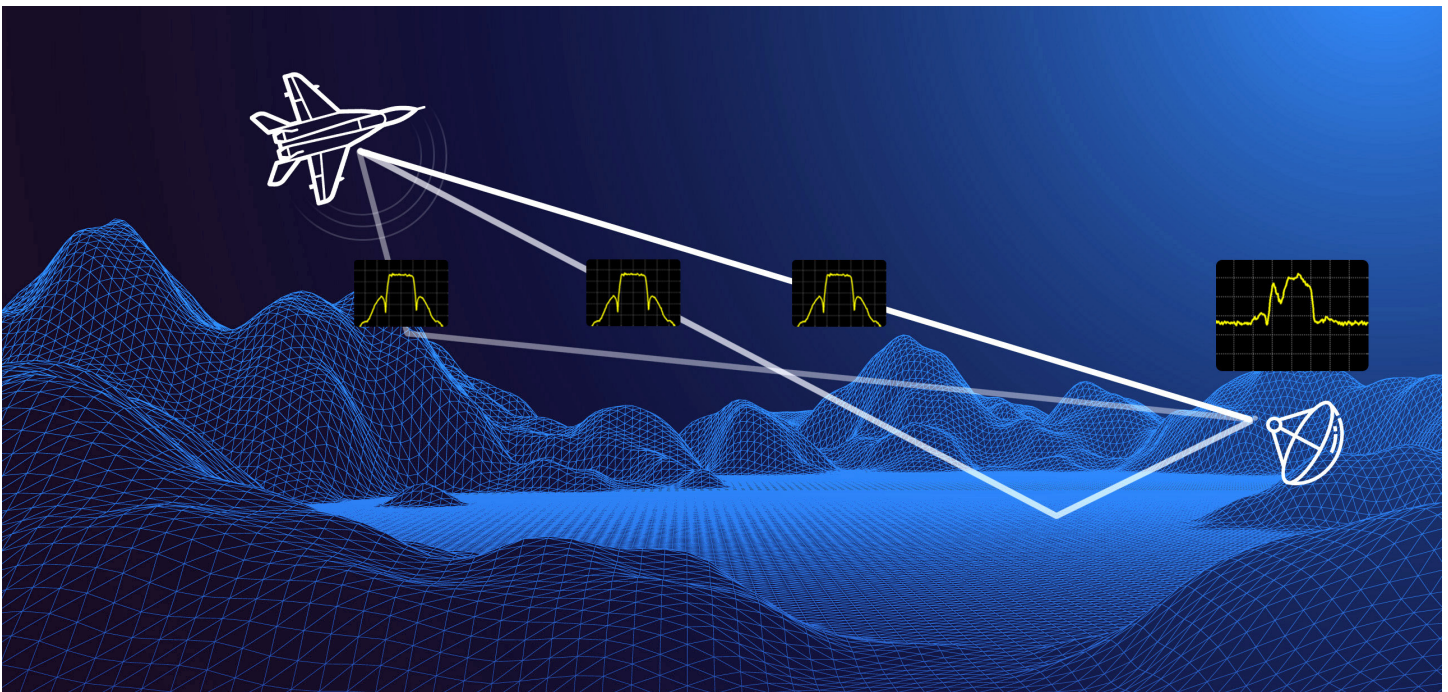

Reflected signals corrupt the received signal

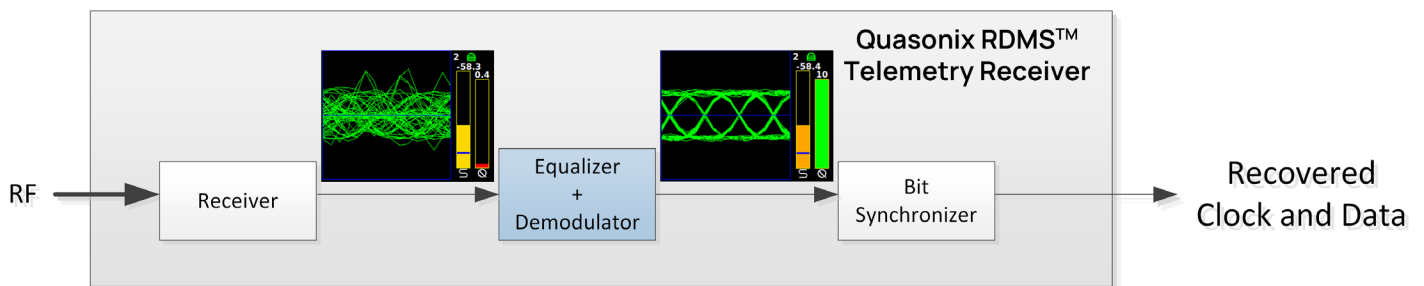

The adaptive equalizer uses digital signal processing, including decision-directed feedback, to provide clean, usable results

Data Quality Metric (DQM) with Real-Time Display

DQM is a measure of received signal quality that is embedded in the PCM stream and based on statistics developed deep inside the demodulator. DQM encodes an estimate of bit error probability (BEP) in a form optimally usable by best source selectors (BSS) such as the Quasonix Maximum Likelihood Stream Combiner™ (MLSC™).

The displayed DQM value (Q on the Signal Graph) ranges from zero to ten. A zero means there is no confidence that the bits were received correctly, while a ten indicates that the probability of bit errors is less than one in ten billion.

In Quasonix RDMS, DQM is calibrated to BER and has been validated by measuring its correlation with BER. This simplified flowchart summarizes the process:

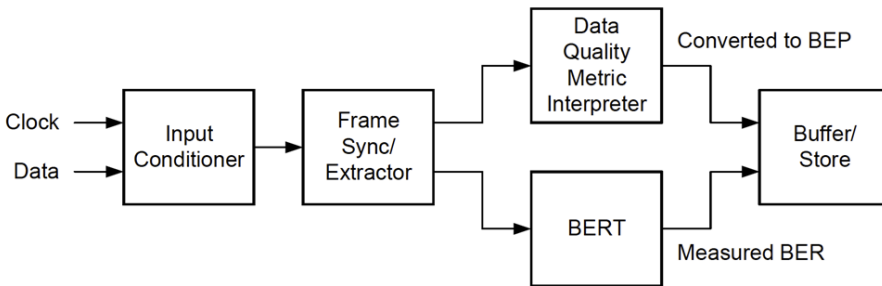
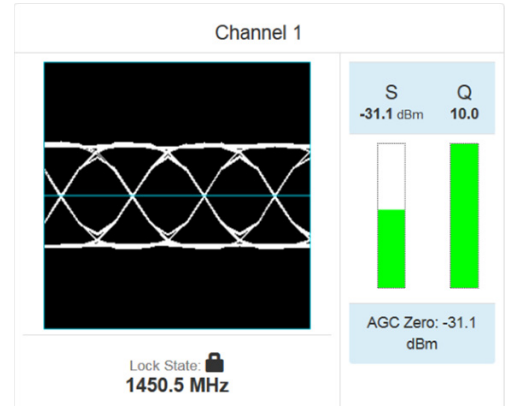

To ensure DQM faithfully reflects BER in real-world conditions, it has been verified to be accurate under a wide variety channel impairments:

- AWGN - static level
- AWGN - dynamic level (step response)
- Dropouts
- In-band and adjacent channel interference
- Phase noise
- Timing jitter
- Static multipath
- Dynamic multipath (similar to break frequency test)

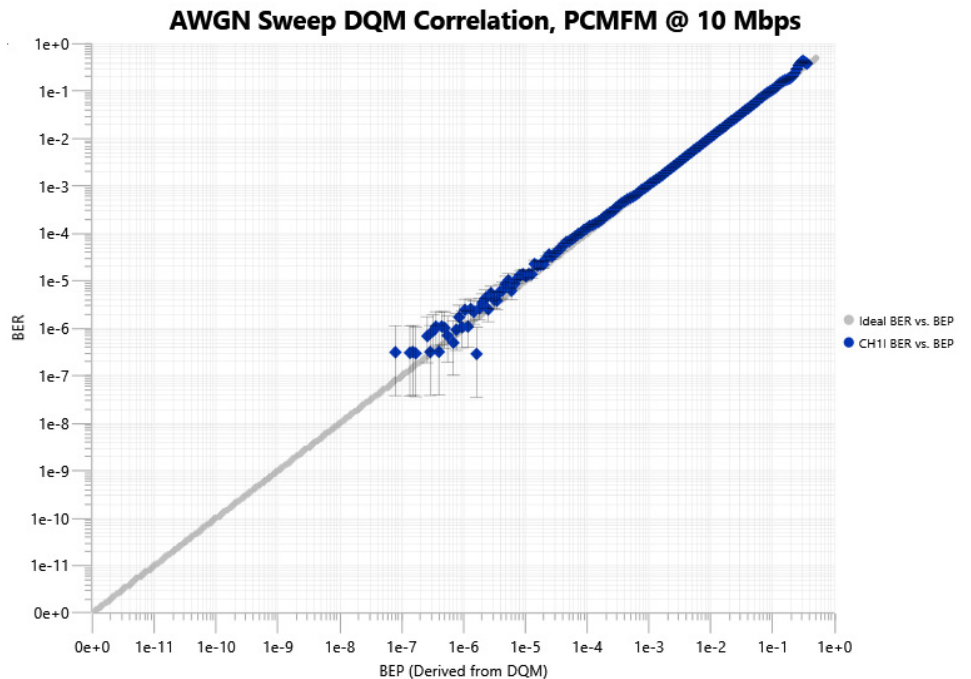

Data Quality Encapsulation (DQE)

DQM is embedded in the PCM stream and based on statistics developed deep inside the demodulator. Data Quality Encapsulation (DQE) bundles payload data with its DQM to give the Best Source Selectors a valid basis for “Best!”

IRIG DQE Format

Header

- 16-bit sync pattern (0xFAC4)
 - MSB first: 1111101011000100
- 16-bit ID word (format TBD)
- 16-bit DQM = $\min(\text{round}(-\log_{10}(\text{LR}) / 12 * (2^{16})), 2^{16} - 1)$
 - 16-bit unsigned integer, ranges from 0 to 65,535
 - Likelihood Ratio (LR) = $\text{BEP} / (1 - \text{BEP})$
 - Easily reversed:
 - $\text{LR} = 10^{(-12 * \text{DQM} / 2^{16})}$
 - $\text{BEP} = \text{LR} / (1 + \text{LR})$
- Q is defined as the “User’s DQM”:
 - $Q = 12 * \text{DQM} / 65536$
 - Represents the exponent of 10 in the LR, which approximates the BEP

| BEP | LR | DQM | Q |
|-------|-------------|-------|-------|
| 0.5 | 1.00 | 0 | 0.00 |
| 1E-01 | 1.11111E-01 | 5211 | 0.95 |
| 1E-02 | 1.01010E-02 | 10899 | 2.00 |
| 1E-03 | 1.00100E-03 | 16382 | 3.00 |
| 1E-04 | 1.00010E-04 | 21845 | 4.00 |
| 1E-05 | 1.00001E-05 | 27307 | 5.00 |
| 1E-06 | 1.00000E-06 | 32768 | 6.00 |
| 1E-07 | 1.00000E-07 | 38229 | 7.00 |
| 1E-08 | 1.00000E-08 | 43691 | 8.00 |
| 1E-09 | 1.00000E-09 | 49152 | 9.00 |
| 1E-10 | 1.00000E-10 | 54613 | 10.00 |
| 1E-11 | 1.00000E-11 | 60075 | 11.00 |
| 1E-12 | 1.00000E-12 | 65535 | 12.00 |

Payload Data

User selectable length, defaults to 4096, except for STC mode, where the default is 3200 bits, and SOQPSK/ LDPC or STC/LDPC mode, where the default is the selected LDPC block size.

Network BW Expansion of ~1%

Better BSS

The Quasonix MLSC uses DQE to provide up to six orders of magnitude improvement over the **best** input stream.

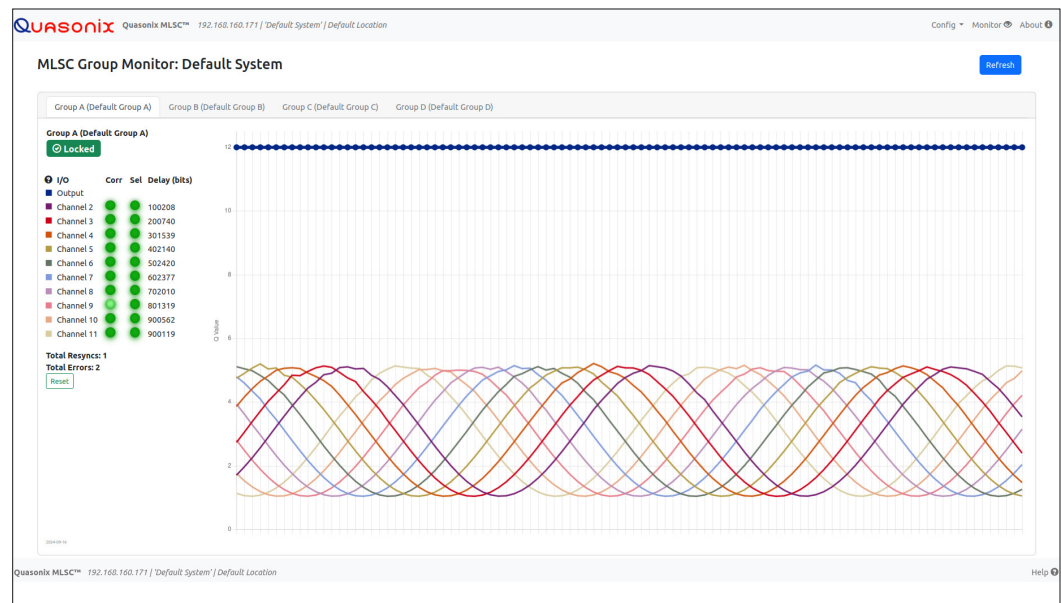

The Power of Diversity

Quasonix makes great receivers, but even the best receiver may be limited by range, obstacles/shading, multipath, interference, etc. That's where diversity comes in. Using multiple copies of the transmitted signal—arriving via separate pathways—can dramatically reduce the likelihood of “data dropouts.” The RDMS supports diversity at two levels: within each rackmount receiver through our innovative Best Channel Selector (BCS), and between multiple rackmount receivers connected to a Best Source Selector (BSS), through Data Quality Encapsulation (DQE).

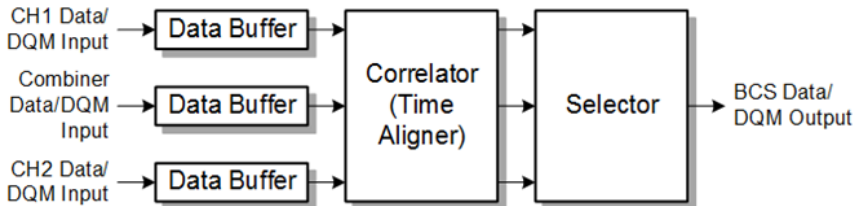

Quasonix Best Channel Selector (BCS)

The BCS selects the best data from Channel 1, Channel 2, and the Combiner on a bit-by-bit basis, based on data quality.

Preserves Combiner gain when possible, remedies Combiner issues if they occur – Diversity combining in the RDMS provides polarization, frequency, or small-scale spatial diversity, depending on the system/antenna configuration. The Combiner uses pre-detection maximal ratio combining to synthesize a composite signal from the Channel 1 and Channel 2 input signals.

This approach provides up to 3 dB performance gain when the only channel impairment is noise. But the Combiner may struggle in the face of other common channel impairments like multipath and interference. Since the BCS selects the channel with the highest data quality, it provides a receiver output that is the best possible data the RDMS can provide, regardless of channel conditions.

Time correlation allows “hit-less” source channel switching – No dropped or duplicated data. Correlation is exceptionally fast and robust, due to small and predictable delays between internal receiver channels. The result is superior dynamic performance, handling dropouts and fast fading with ease.

Optimized selection accounts for statistically dependent errors – The optimal selection strategy for statistically independent sources may backfire if sources have correlated errors, which is inevitable with the Combiner and its source channels (Channel 1 and Channel 2). The BCS—unlike an external BSS—“knows” this and simply selects the best channel. This strategy guarantees the RDMS output will always be the best data available.

Outputs composite RDMS DQM and data, via DQE – Facilitates range-wide spatial diversity, using a single data stream per receiver (on the Combiner clock and data signals).

Quasonix Maximum Likelihood Stream Combiner (MLSC)

The MLSC (sold separately) creates the best signal source from multiple receivers—outputting data that is better than any individual input source, automatically and transparently.

Correlates sources across almost unlimited range – A wide range of source arrival delays are handled, potentially up to multiple seconds.

Optimal selection using DQM removes bit errors anywhere in the data stream – All correlated input sources contribute information to the output data. This results in a large improvement in data quality because most bit errors are uncorrelated across diverse sources. Typical improvement is a factor of 1000x in bit error rate with three sources. Best of all, it does not require any input source to be error free!

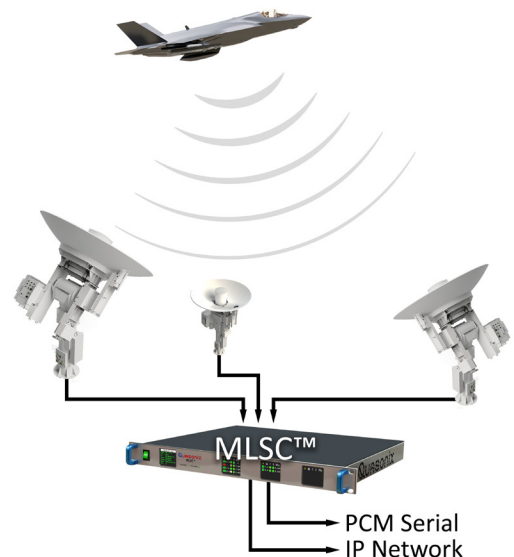

Telemetry over IP (TMoIP) Option

The Quasonix TMoIP Processor (QTP™) core provides IRIG 218-20 compliant telemetry transport in a 3-channel integrated solution embedded in a 1U or 3U RDMS receiver (RDMS with the IP2 option). It provides accurate, reliable transport of all received telemetry data streams from the RDMS to the range network, while offering a multitude of features.

| PCM Telemetry Interface | |
|---|--|
| Integrated Solution | RDMS integrated solution supports 3 channels of PCM input, one each for Channel 1, Channel 2, and Combiner |
| PCM Telemetry Clock and Data Rates of 100 kbps to 46 Mbps Per Channel | Each channel supports an independent clock rate; bit rate detected automatically—no configuration needed |
| Configurable TX/RX Clock and Data Polarity with Auto Clock Edge Detection | Clocking edge can be automatically determined via relationship with data (most reliable edge is selected) |

| Network Interface | |
|---|--|
| Two 1000 Base-T Gigabit Ethernet RJ45 Ports | Separate ports for configuration and data |
| IRIG 218-20 Packet Format | Support for the latest standard with first bit timestamping |
| Per Channel Configuration | Each channel is independently configurable for maximum flexibility |
| Configurable DQE Frame Alignment | TMoIP packet starts with a DQE frame and contains its full payload |

| User Interface | |
|--|--|
| Local and Remote Management for Configuration and Monitoring | Web Browser Based UI for Command, Control, Health, and Status |
| BER Test Mode with Generator and Analyzer | Allows full testing of system configuration and cabling prior to mission start |
| Easy Field Updates | Software updates may be installed by the customer on-site |

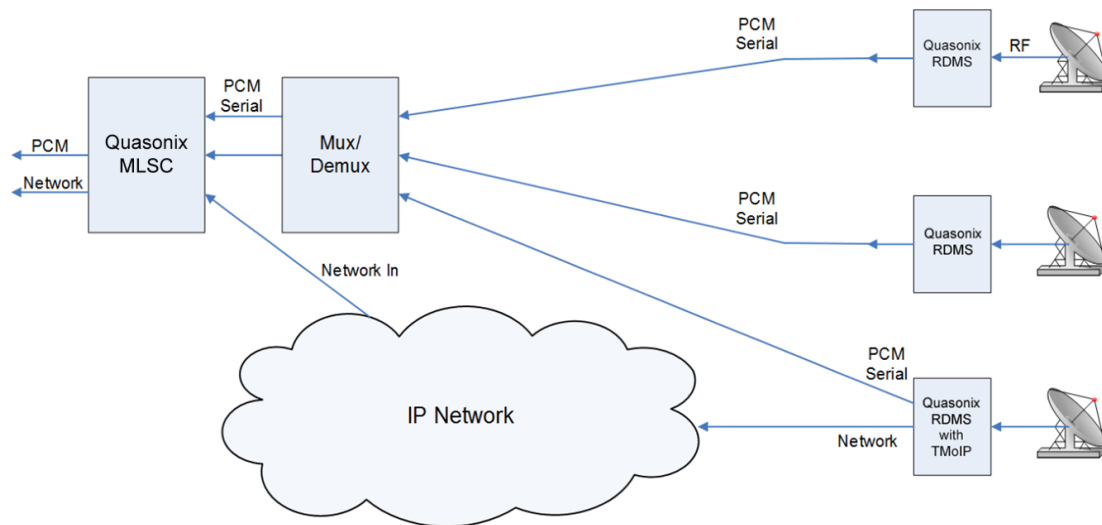

Fielded 1U and 3U RDMS are factory upgradable to add 3-channel TMoIP capability (IP2 option).

Rackmount Receiver Features

Low-Density Parity Check (LDPC) Error Correction

Quasonix is the only vendor in the market offering LDPC encoding and decoding for serial streaming telemetry. This approach yields nearly triple the communications range, yet it can do so with 22%, or even 34%, less bandwidth than conventional PCM/FM. Payload bit rates up to 35 Mbps are supported.

Improves Link Margin by 8.8 to 9.4 dB at BER = 1e-5 – Link margin improvement is equivalent to nearly tripling the operating distance on your telemetry link

Fully Integrated Forward Error Correction System – Transmitter automatically synthesizes expanded over-the-air bit rate for encoded blocks and receiver seamlessly converts back to continuous output at the user bit rate; Operation is completely transparent to data devices

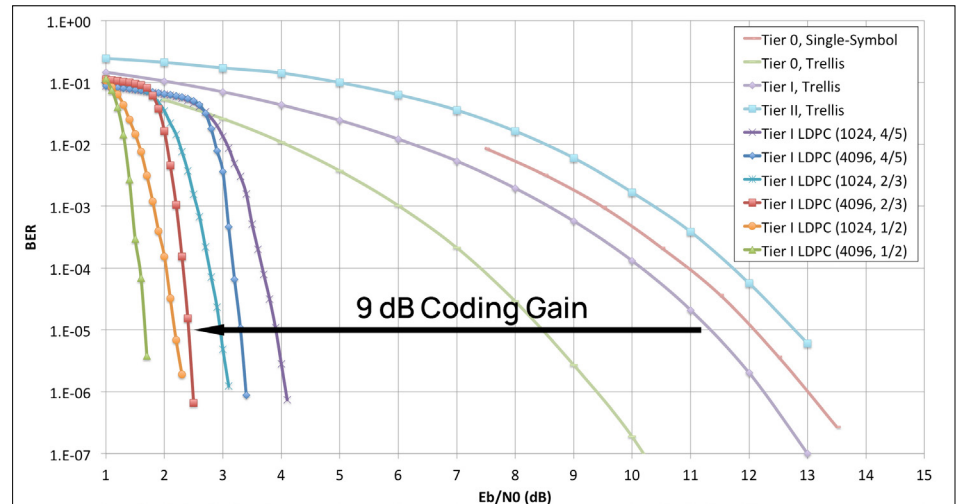

The IRIG standard calls out six variants of LDPC codes—all combinations of two different information block sizes ($k=4096$ bits and $k=1024$ bits) and three different code rates ($r=1/2$, $r=2/3$, and $r=4/5$). The larger block size offers better decoding performance in a static channel, but may work less well in a dynamic channel with fast fading or other impairments. Lower code rates also provide better decoding performance at the cost of increased occupied bandwidth.

Already own Quasonix equipment? The LDPC feature can be retrofitted to most Quasonix transmitters and receivers.

LDPC Error Correction has been adopted by the Range Commander's Council, IRIG 106-17, Appendix 2-D

Ethernet Via Telemetry System

Redefine the “Local” in Local Area Network. With the Quasonix Ethernet Via Telemetry (EVTM) system, your test article can be on your ground station LAN, just like any other computer or Ethernet appliance. With an Ethernet switch in your test article, you can connect cameras, Voice over IP, computers, etc. to your network on the ground.

High Speed Ethernet Traffic Over Telemetry Links – Ethernet telemetry data rates up to 40 Mbps using standard Ethernet protocols (bidirectional protocols require a bidirectional RF link).

Enables Ethernet Data Transmission for a Wide Variety of Applications – Multimedia streaming, data source selection, data source isolation and forwarding, source rate and coding control in reaction to channel impairments, network extension, Voice over IP (VoIP), COTS-based Ethernet products such as Industrial Control Sensor Devices and data recorders

Complete Telemetry System – An Ethernet solution package that includes an integrated Quasonix TIMTER™ Transmitter and a Quasonix Compact RDMS Telemetry Receiver for the downlink. The uplink includes a TIMTER Transmitter and a Quasonix Rackmount RDMS Telemetry Receiver.

Supports All TCP/IP Packet Types – Streaming UDP packets, TCP connections, ICMP and SNMP messages are all passed over the air. Connection-oriented traffic requires a bidirectional link.

Rackmount Receiver Features (Continued)

Space Time Coding Solution

Problem: “Two-antenna interference”

- Upper and lower antennas are required to provide LOS path during aircraft maneuvers.
- Signals can cancel each other, creating antenna pattern nulls.

Solution: Space Time Coding (STC)

Advantages of the Quasonix Space Time Coding Solution:

Eliminates link outages caused by the “two-antenna problem”

- Improves behavior of received signal power
- Improves overall link availability

Two transmit/One receive configuration

- Compatible with standard telemetry applications and installations

STC signal spectrum is the same as SOQPSK, with minimal bandwidth expansion (4%)

Available as a software upgrade to Quasonix RDMS Telemetry Receivers.

Note: Quasonix dual transmitter required.

Illustrations and flight test data used with permission of the authors—originally published in “Space-Time Coding for Aeronautical Telemetry: Part II” - Experimental Results by Michael Rice, Brigham Young University, and Kip Temple, Air Force Flight Test Center, Edwards AFB, California, USA, in Proceedings of the International Telemetry Conference, Las Vegas, NV, October, 2011.

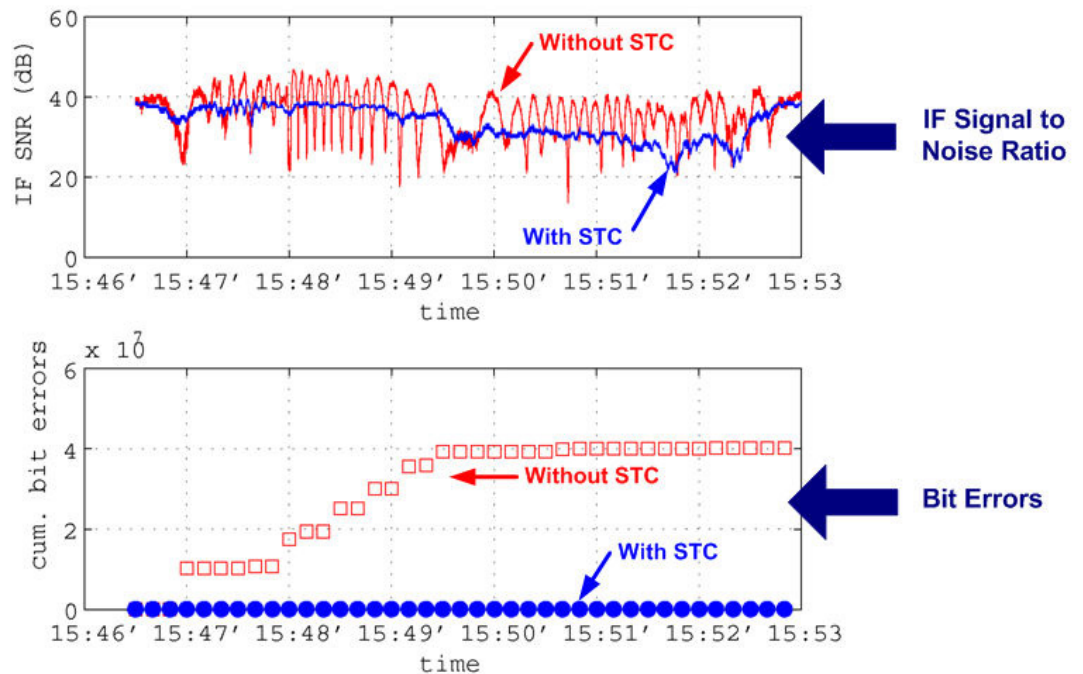

Space Time Coding has been adopted by the Range Commander's Council, IRIG 106-17, Appendix 2-E

Rackmount Receiver Features (Continued)

Bit Error Rate Testing (BERT)

User-selectable Pattern

- PN6, PN9, PN11, PN15, PN17, PN20, PN23, PN31
- Any fixed-length pattern from 2 to 32 bits

Standard Operating Modes

- Continuous
- Single
- Repeating

Accurate measurement even above 40% bit error rate

Test Termination Selection

- Bit count limit
- Error count limit
- Time limit

Loggable text results

- Human-friendly
- Excel-friendly

Automatic data inversion detection

| ER | Time | Bit Count | Error Count | Error Rate |
|-----|----------------|-----------|-------------|------------|
| # ! | 0:00:00:03.772 | 3.773e+07 | 2 | 5.301e-08* |
| # ! | 0:00:00:04.023 | 4.023e+07 | 2 | 4.971e-08* |
| # ! | 0:00:00:04.276 | 4.276e+07 | 2 | 4.677e-08* |
| # ! | 0:00:00:04.527 | 4.528e+07 | 2 | 4.417e-08* |
| # ! | 0:00:00:04.779 | 4.780e+07 | 2 | 4.184e-08* |
| >>> | 0:00:00:05.000 | 5.000e+07 | 2 | 4.000e-08* |
| # ! | 0:00:00:00.251 | 2.512e+06 | 0 | 0.000e+00* |
| # ! | 0:00:00:00.503 | 5.032e+06 | 0 | 0.000e+00* |
| # ! | 0:00:00:00.757 | 7.574e+06 | 2 | 2.641e-07* |
| # ! | 0:00:00:01.011 | 1.011e+07 | 2 | 1.978e-07* |
| # ! | 0:00:00:01.263 | 1.264e+07 | 2 | 1.582e-07* |

Example display with a five (5) second repeating test. An asterisk * after the Error Rate indicates the data is inverted.

Simplified Block Diagram

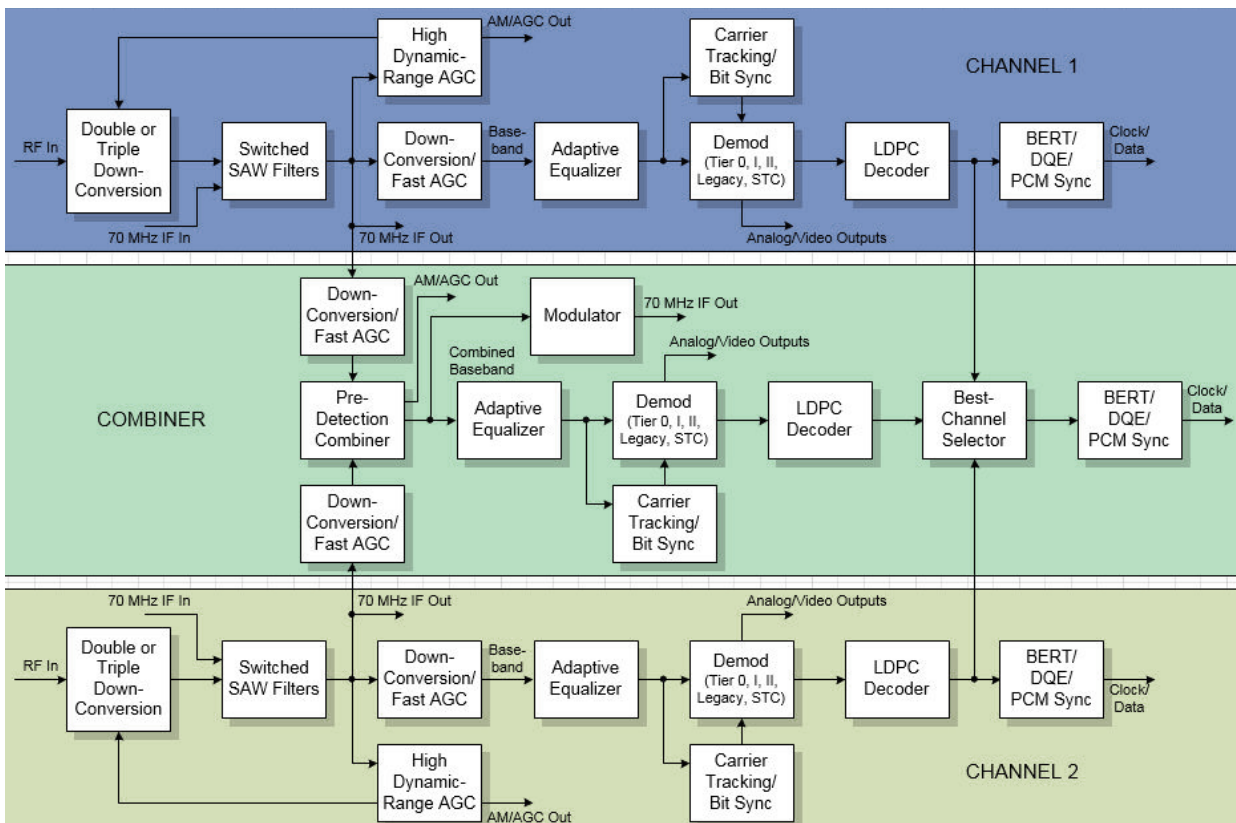

Demodulator Synchronization Performance

Synchronization Overview

Quasonix is the only vendor in the telemetry market offering trellis demodulation in all ARTM modes. Not only does this approach yield BER results that are less than 0.2 dB from the theoretical limits, but it brings unprecedented synchronization performance.

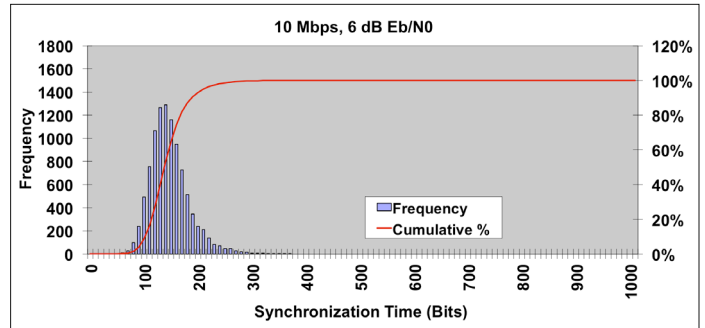
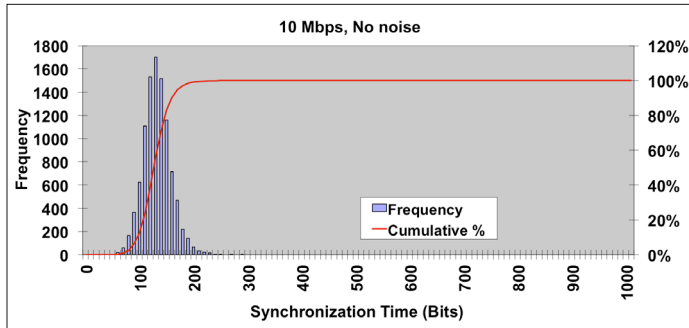

Synchronization Time

The entire Quasonix receiver and demodulator product line offers extremely fast synchronization in all modes. Our trellis-based synchronization engine provides sync times as short as 100 bits on average.

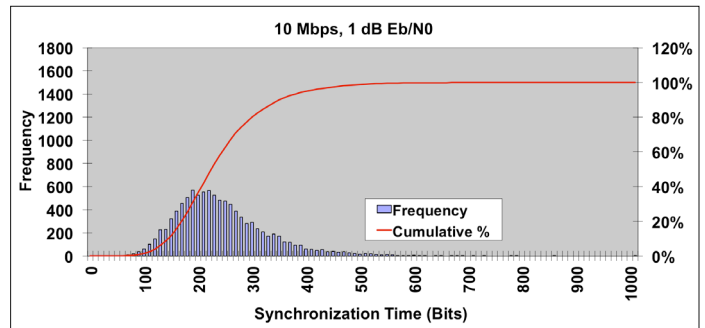
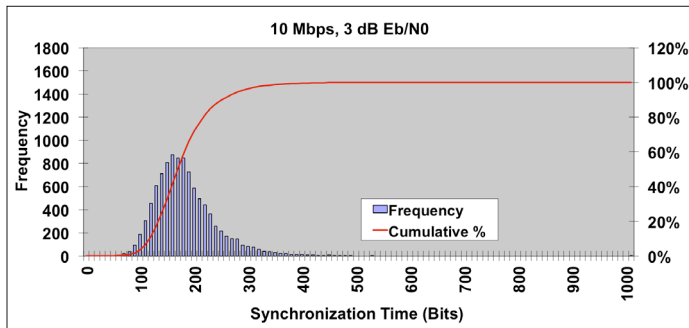

Synchronization Threshold

Only Quasonix can show synchronization times at negative Eb/N0 values because we're the only vendor with trellis demodulators that can operate in this region. Our ability to achieve synchronization at such low signal to noise ratios means that we can maintain bit count integrity through extremely deep fades. This allows the user's crypto devices to stay synchronized under the most severe fading conditions, thereby eliminating the long data outages that occur when the crypto devices lose sync.

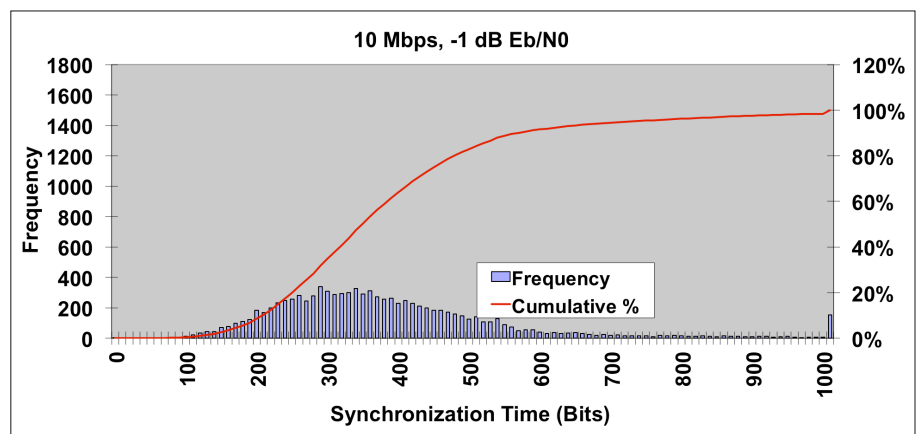

Rear Panel Connectors

| | 1U | | | 3U | | |
|-----------------------|----------------------|-----------|-----------|-----------|-----------|-----------|
| | Channel 1 | Channel 2 | Channel 3 | Channel 1 | Channel 2 | Channel 3 |
| Receiver Nomenclature | Connector Number/pin | | | | | |
| Clock A | J1 | J15 | J25 | J1 | J26 | J51 |
| Data A | J2 | J16 | J26 | J2 | J27 | J52 |
| Clock B | J9/14 | J9/19 | J9/25 | J6 | J31 | J56 |
| Data B | J9/15 | J9/20 | J9/24 | J7 | J32 | J57 |
| Clock C | - | - | - | J11 | J36 | J61 |
| Data C | - | - | - | J12 | J37 | J62 |
| Clock D | - | - | - | J16 | J41 | J66 |
| Data D | - | - | - | J17 | J42 | J67 |
| DAC A | J5 | J19 | J29 | J3 | J28 | J53 |
| DAC B | J6 | J20 | J30 | J8 | J33 | J58 |
| DAC C | J11 | J13 | - | J13 | J38 | J63 |
| DAC D | J12 | J14 | - | J18 | J43 | J68 |
| AGC OUT | J3 | J17 | J27 | J9 | J34 | J59 |
| AM OUT | J4 | J18 | J28 | J4 | J29 | J54 |
| AUX ANALOG A Out | - | - | - | J14 | J39 | J64 |
| AUX ANALOG B Out | - | - | - | J19 | J44 | J69 |
| IF IN | J7 | J21 | - | J21 | J46 | - |
| IF Out | J8 | J22 | J32 | J24 | J49 | J72 |
| 70MHz Mod Out | - | - | - | J22 | J47 | J72 |
| Sync Detect | J9/16 | J9/21 | J9/23 | J5 | J30 | J55 |
| Demod Lock | J9/3 | J9/8 | J9/11 | J10 | J44 | J60 |
| No Connection | J9/4 | J9/9 | J9/10 | J15/1 | J40/1 | J65/1 |
| RS422/Clock A_p | J23/1 | J23/5 | J23/9 | J20/1 | J45/1 | J70/1 |
| RS422/Clock A_n | J23/14 | J23/18 | J23/22 | J20/14 | J45/14 | J70/14 |
| RS422/Data A_p | J23/2 | J23/6 | J23/10 | J20/2 | J45/2 | J70/2 |
| RS422/Data A_n | J23/15 | J23/19 | J23/23 | J20/15 | J45/15 | J70/15 |
| RS422/Clock B_p | J23/3 | J23/7 | J23/11 | J20/3 | J45/3 | J70/3 |
| RS422/Clock B_n | J23/16 | J23/20 | J23/24 | J20/16 | J45/16 | J70/16 |
| RS422/Data B_p | J23/4 | J23/8 | J23/12 | J20/4 | J45/4 | J70/4 |
| RS422/Data B_n | J23/17 | J23/21 | J23/25 | J20/17 | J45/17 | J70/17 |
| RS422/Clock C_p | - | - | - | J20/5 | J45/5 | J70/5 |
| RS422/Clock C_n | - | - | - | J20/18 | J45/18 | J70/18 |
| RS422/Data C_p | - | - | - | J20/6 | J45/6 | J70/6 |
| RS422/Data C_n | - | - | - | J20/19 | J45/19 | J70/19 |
| RS422/Clock D_p | - | - | - | J20/7 | J45/7 | J70/7 |
| RS422/Clock D_n | - | - | - | J20/20 | J45/20 | J70/20 |
| RS422/Data D_p | - | - | - | J20/8 | J45/8 | J70/8 |
| RS422/Data D_n | - | - | - | J20/21 | J45/21 | J70/21 |

| | | | | | |
|--------------|----------|--------|------------|----------|------|
| Color Legend | 75 Ω BNC | MDM-25 | 50 Ω M MCX | 50 Ω BNC | DB-9 |
|--------------|----------|--------|------------|----------|------|

Rackmount Receiver Ordering Information

You CAN have it all!

Imagine five frequency bands all in a compact 1U package OR in a 3U package with touchscreen—and with Quasonix's Extended Tuning Range option, our receivers will tune from 200 MHz to 2500 MHz and 4.4 GHz to 5.25 GHz, meeting or exceeding the range of the competition.



Third-Generation 1U Chassis – The reliable, premium performance you've come to expect from Quasonix

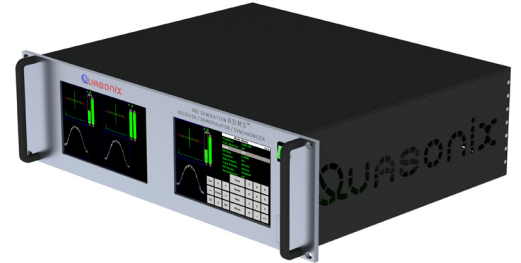

3U Touchscreen Chassis – Same RDMS functionality as the 1U with the convenience of touchscreens and unparalleled output capability

| Available Options | |
|-------------------|---|
| Option | Option Description |
| 14 | 14 SAW filters (adds 70 kHz, 1.4, 3, 6, 14, and 28 MHz filters) |
| CS | Cybersecurity |
| EQ | Adaptive Equalizer |
| K7 | K7 Viterbi Decoder (k=7 rate 1/2) |
| IP2 | Telemetry Over IP |

MDM-25 Cables

The RS-422 connectors must be connected to a 12 twisted pair shielded cable, such as a Glenair 177-740-2-25CS4K1-36MCN. This particular cable is 36 inches or 3 feet long. Other lengths are available.

Note: Only 8 twisted pairs are used per 3U RDMS connector. The 1U RDMS uses all 12 twisted pairs.

Rackmount RDMS Part Numbering Example

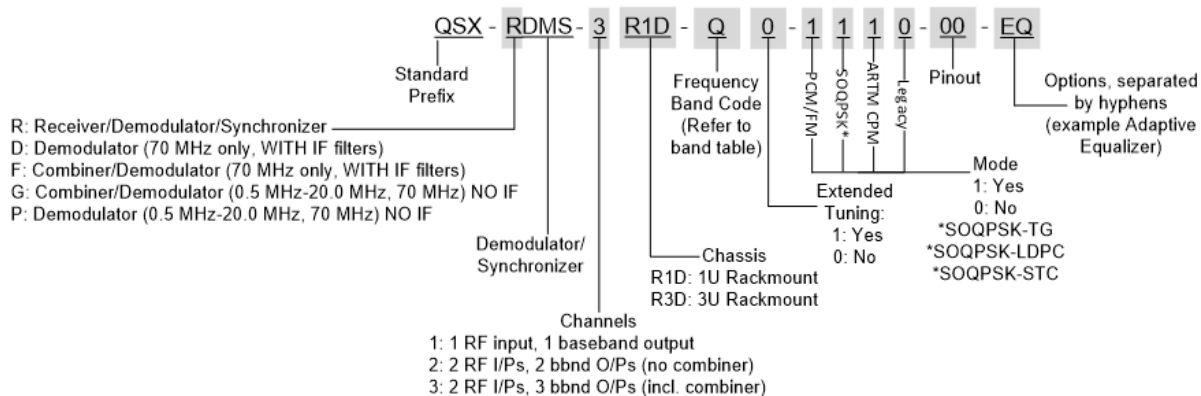

Rackmount Receiver Band Configurations

| Freq. Code | 200.00 ← Extended | 1415.0 ← Extended → 1585.0 | 1650.0 ← Extended → 1855.0 | 2185.0 ← Extended → 2500.0 | 4400.0 ← Base → 5150.0 | Extended → 5250.0 |
|------------|-----------------------|----------------------------|----------------------------|----------------------------|------------------------|-------------------|
| A | 400.0 ← Base → 1150.0 | 1235.5 ← Base → 534.5 | 1750.0 ← Base → 1850.0 | 2200.0 ← Base → 2394.0 | | |
| C | | | | | | |
| E | | | | | | |
| F | | | | | | |
| G | | | | | | |
| H | | | | | | |
| J | | | | | | |
| K | | | | | | |
| L | | | | | | |
| M | | | | | | |
| P | | | | | | |
| Q | | | | | | |
| R | | | | | | |
| S | | | | | | |
| U | | | | | | |
| W | | | | | | |
| X | | | | | | |
| Y | | | | | | |
| Z | | | | | | |

Frequency Gap
 Standard (Base) Frequency Range
 Extended Frequency Range
(available by selecting Extended Tuning = 1 in part number)

*Also Available:
 Band Code 7: 70MHz standard range, 0.5 MHz - 20 MHz, 70 MHz extended range
 Band Code T: 2025.0 MHz to 2110.0 MHz standard range

Receiver

| | |
|--|--|
| Type | Dual-conversion superheterodyne |
| Input RF Frequency | Refer to page 17 |
| Tuning resolution | Tunes in 62.5 kHz increments, to the 70 MHz IF output; after the 70 MHz IF output, receiver tunes in increments of less than 1 Hz |
| Frequency stability | 1 ppm over temperature; 1 ppm per year aging |
| Reference oscillator | 20 MHz |
| Noise figure | 3.5 dB (typical), 5 dB (maximum) |
| LO phase noise, measured at 70 MHz IF output | -115 dBc/Hz @ 1 MHz offset |
| Maximum RF input | +20 dBm (+10 dBm for C-band) |
| Available gain (to 70 MHz IF output) | 114 dB |
| Gain control | 128 dB control range; User selectable: AGC or MGC (AGC freeze) |
| AGC load impedance | 1 KOhm |
| AGC time constant | Adjustable to any value from 0.1 ms to 1000 ms |
| First IF bandwidth | 60 MHz (nominal) |
| IF rejection | > 90 dB |
| Image rejection | 70 dB |
| RF input impedance | 50 ohms |
| VSWR | 3:1 Max; 2:1 Typical |

Second IF

| | | | | | | | | | | | | | | | | | | | |
|-------------------------------------|--|------------------------------|----------------------------|---------|--|---------------------------|---------|--|--------------------------|--------|--|-------------------------|---------|-----------|--|---------------|--------------------------|--|------------------------------|
| IF frequency | 70 MHz | | | | | | | | | | | | | | | | | | |
| IF output level, nominal (AGC mode) | <table border="0"> <tr> <td>Channel 1 and 2:</td> <td>70 and 250 kHz bandwidths:</td> <td>-15 dBm</td> </tr> <tr> <td></td> <td>0.5 – 4.5 MHz bandwidths:</td> <td>-10 dBm</td> </tr> <tr> <td></td> <td>6 and 10 MHz bandwidths:</td> <td>-5 dBm</td> </tr> <tr> <td></td> <td>14 – 40 MHz bandwidths:</td> <td>-15 dBm</td> </tr> <tr> <td>Combiner:</td> <td></td> <td>-5 to -10 dBm</td> </tr> <tr> <td>Channel 1 and 2 Mod Out:</td> <td></td> <td>-5 to -10 dBm (3U RDMS only)</td> </tr> </table> | Channel 1 and 2: | 70 and 250 kHz bandwidths: | -15 dBm | | 0.5 – 4.5 MHz bandwidths: | -10 dBm | | 6 and 10 MHz bandwidths: | -5 dBm | | 14 – 40 MHz bandwidths: | -15 dBm | Combiner: | | -5 to -10 dBm | Channel 1 and 2 Mod Out: | | -5 to -10 dBm (3U RDMS only) |
| Channel 1 and 2: | 70 and 250 kHz bandwidths: | -15 dBm | | | | | | | | | | | | | | | | | |
| | 0.5 – 4.5 MHz bandwidths: | -10 dBm | | | | | | | | | | | | | | | | | |
| | 6 and 10 MHz bandwidths: | -5 dBm | | | | | | | | | | | | | | | | | |
| | 14 – 40 MHz bandwidths: | -15 dBm | | | | | | | | | | | | | | | | | |
| Combiner: | | -5 to -10 dBm | | | | | | | | | | | | | | | | | |
| Channel 1 and 2 Mod Out: | | -5 to -10 dBm (3U RDMS only) | | | | | | | | | | | | | | | | | |
| IF output impedance | 50 ohms | | | | | | | | | | | | | | | | | | |
| VSWR | 2:1 Max; 1.5:1 Typical | | | | | | | | | | | | | | | | | | |
| IF bandwidths | 250 kHz, 500 kHz, 1 MHz, 2 MHz, 4.5 MHz, 10 MHz, 20 MHz, 40 MHz. Automatic selection based on modulation type and data rate, with manual override. Optional: 70 kHz, 1.4 MHz, 3 MHz, 6 MHz, 14 MHz, 28 MHz | | | | | | | | | | | | | | | | | | |

Playback Demodulator IF In, Channel 1 and 2

| | |
|------------------------|--|
| Input Center Frequency | .075-20 MHz, 70 MHz through any SAW filter |
| Input Level | -30 dBm \pm 10 dB |
| Input Impedance | 50 ohms, nominal |

Demodulator

| | |
|---|---|
| Demodulator type | ARTM Tier 0 (PCM/FM), Tier I (SOQPSK-TG), Tier II (Multi-h CPM) Legacy suite: Analog FM, BPSK, QPSK, Offset QPSK (OQPSK), Asymmetric QPSK (AQPSK), Unbalanced QPSK (UQPSK), Asymmetric Unbalanced QPSK (AUQPSK), Digital PM, Space Time Coding (STC) |
| Bit Rates After LDPC encoding, if applicable | Tier 0: 24 kbps to 23 Mbps in 1 bps steps Tier I: 100 kbps to 46 Mbps in 1 bps steps Tier II: 1 Mbps to 46 Mbps in 1 bps steps STC: 5 Mbps to 22 Mbps in 1 bps steps Legacy: 25 kbps to 23 Mbps in Analog FM, 25 kbps to 23 Mbps in BPSK, 50 kbps to 46 Mbps in QPSK in 1 bps steps |
| Synchronization time Average, at BER = 1e-5 | Tier 0: 250 bits, Tier I: 385 bits, Tier II: 2,800 bits |
| Synchronization acquisition threshold | Tier 0: -5.0 dB Eb/N0; RF Input (dBm): -115.0 (1 Mbps), -105.0 (10 Mbps) Tier I: -4.0 dB Eb/N0; RF Input (dBm): -114.0 (1 Mbps), -104.0 (10 Mbps) Tier II: -8.0 dB Eb/N0; RF Input (dBm): -118.0 (1 Mbps), -108.0 (10 Mbps) |
| Synchronization dropout threshold | Tier 0: -10.0 dB Eb/N0; RF Input (dBm): -120.0 (1 Mbps), -110.0 (10 Mbps) Tier I: -6.0 dB Eb/N0; RF Input (dBm): -116.0 (1 Mbps), -106.0 (10 Mbps) Tier II: -15.0 dB Eb/N0; RF Input (dBm): -125.0 (1 Mbps), -115.0 (10 Mbps) |
| Sensitivity BER = 1e-5 | Tier 0: 8.6 dB Eb/N0; RF Input (dBm): -101.4 (1 Mbps), -91.4 (10 Mbps) Tier I: 11.2 dB Eb/N0; RF Input (dBm): -98.8 (1 Mbps), -88.8 (10 Mbps) Tier II: 13.0 dB Eb/N0; RF Input (dBm): -97.0 (1 Mbps), -87.0 (10 Mbps) |

Bit Synchronizer

| | |
|--------------------|--|
| Input codes | NRZ-L/M/S, BI Φ -L/M/S, RZ, DM-M/S, M2-M/S |
| Output codes | NRZ-L; or input code unaltered |
| Data and clock out | TTL (BNC) or RS-422 |
| Lock detector out | TTL |
| Derandomizer | Standard IRIG 15-stage polynomial, selectable On/Off |

Video

| | |
|---------------------------|--|
| Video out DC to 35 MHz | 1U—Quad wideband outputs: Ch1 and Ch2; Dual wideband outputs, Combiner 3U—Quad wideband outputs: Ch1, Ch2, and Combiner |
| Video filter bandwidth | User programmable |
| Output level | 1 Vp-p nominal, 4 Vp-p maximum |
| Video de-emphasis | Selectable Off/NTSC/PAL |

Environmental

| | |
|------------------------------|---|
| Operating Temperature | 0°C to +50°C |
| Non-operating Temperature | -20 C to +70°C |
| Operating Humidity | 0 to 95% (non-condensing) |
| Altitude | Up to 30,000 ft. (with the no displays options) |

Physical

| | |
|--------|---|
| Size | 1U rackmount chassis: 18.95" wide, 1.72" tall, 14.0" rack depth, 14.74" overall depth 3U rackmount chassis: 18.95" wide, 5.22" tall, 14.06" rack depth, 14.80" overall depth |
| Weight | 1U: 11.4 lbs. (dual-channel) 3U: 16.0 lbs |
| Power | 100 to 240 VAC, 50/60 Hz |

Reinventing Telemetry™

With a razor-sharp focus on the aeronautical telemetry market and a team rich in talent, experience, and sheer determination, Quasonix is able to consistently design, develop, and manufacture what our customers regard as market-leading telemetry products.



QUASONIX

All Quasonix products are under U.S. Dept. of Commerce jurisdiction. Receivers are categorized as 5A991.
ISO 9001:2015 Certified | Specifications subject to change without notice.

6025 Schumacher Park Drive West Chester, OH 45069 | 1-513-942-1287 | www.quasonix.com