

# HyperTrack™ Telemetry Antennas



## Digital Dexterity

Quasonix antennas offer a new generation of performance, usability, and versatility. The bedrock of our systems is the HyperTrack™ Antenna Controller (HTAC), where real-time processing is done in FPGA hardware, yielding faster response and extremely smooth, accurate tracking. With reflectors ranging from 3 to 24 feet (1 to 7.3 meters) in diameter, systems covering the full telemetry frequency range, and modular designs conceived with long service life, minimal maintenance, and expandability in mind, we have an antenna to fit your needs – and exceed your expectations. Quasonix is... Reinventing Telemetry™.

**Decades of Innovation** – The Quasonix antenna team comprises design, manufacturing, and test experience dating back to the 1980s, with several hundred systems delivered—many still in use 20 years or more after commissioning.

**Complete Tracking Antenna Systems** – Quasonix offers the entire system: pedestals, reflectors, feeds, motors, servos, slip rings, and the industry's most full-featured antenna control unit—all backed by the legendary Quasonix technical support.

**HyperTrack is a Complete System Approach** – HyperTrack incorporates dynamic tracking loop adjustments, interference mitigation techniques, and advanced system monitoring and feedback. All tracking calculations are done in FPGA hardware, with very low and very consistent latency. The improvement in tracking accuracy provided by HyperTrack renders conventional AM/AGC control schemes obsolete.

**Revolutionary HyperTrack Digital Control Protocol** – In addition to the normal AM and AGC interfaces, the HyperTrack antenna control unit (HTAC) also supports the advanced HyperTrack digital control interface, included in every 3rd Generation Quasonix RDMS™ receiver shipped since late 2017.

**Modular System Design** – Robust tracking systems are available to support reflectors from 3 feet to 24 feet in diameter; Quasonix has right-sized antennas for fixed, mobile, or portable applications.

**Plano-Centric Drive Systems** – Advanced design delivers positioning accuracy and repeatability to 0.01 degrees. Sealed gearbox housings require no adjustments and have provided flawless operation for 20 years—and still counting.

**Lifetime Updates and Support** – All HyperTrack systems include free lifetime software updates, a three-year hardware warranty, and lifetime customer support from the team that designs and builds our products.

# HyperTrack System Diagram

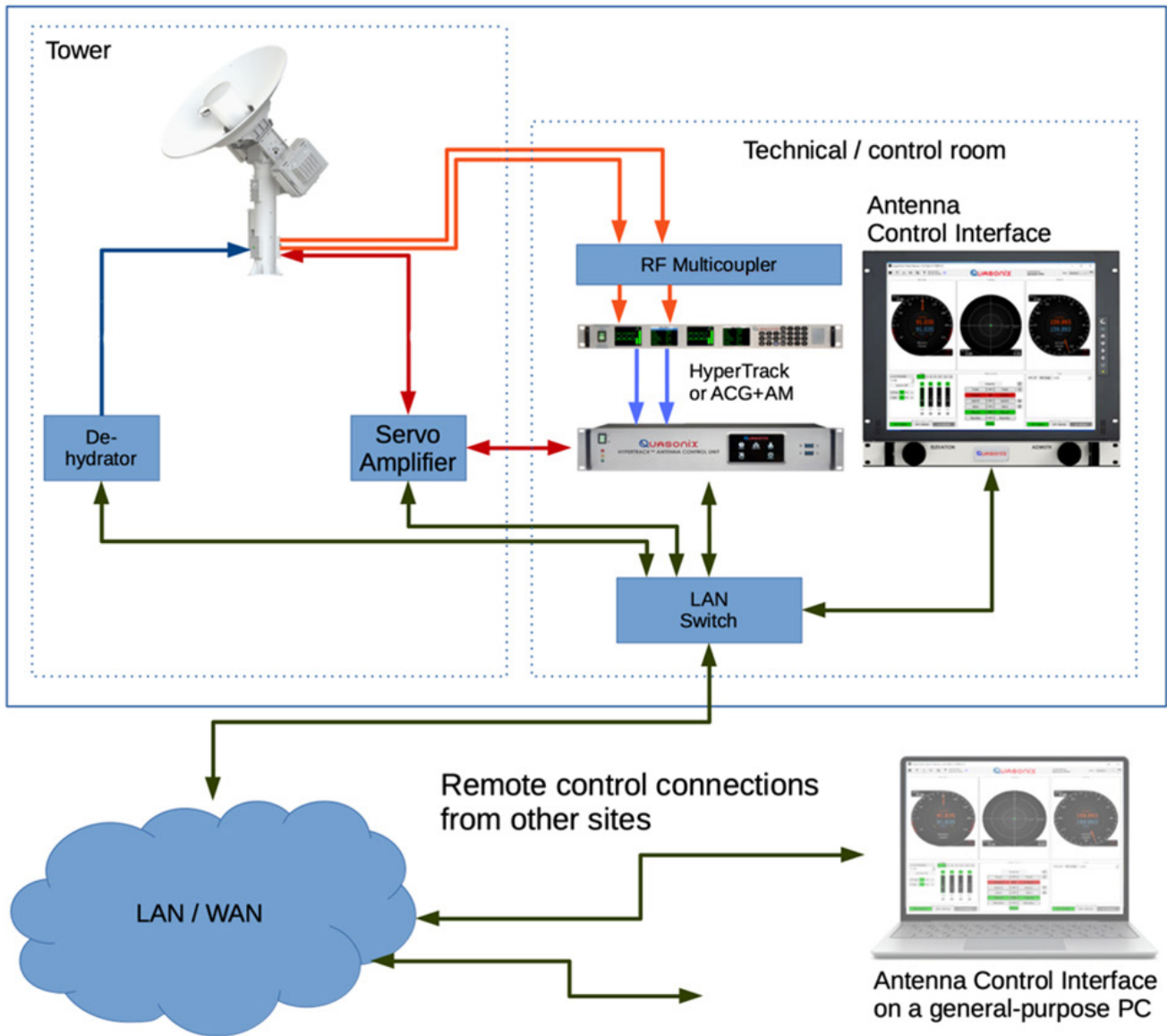

# HyperTrack Pedestals

HyperTrack pedestals are the nucleus of every Quasonix antenna system. This mechanical foundation must position the antenna quickly and accurately, and do so for many years with minimal maintenance. That's why every element of the pedestal is designed with very high performance margins:

**Motors** – The total package of drive motors, servos, and gearing are selected to guarantee delivery of the full range of velocity and accelerations after accounting for worst case wind loading. Your antenna will always deliver its specified performance.

**Bearings** – All pedestals use sealed, maintenance-free bearings, designed to carry at least double the weight of the moving parts (reflector, feed, camera, etc.). Your antenna will track smoothly, for years.

**Plano-centric Gearboxes** – Plano-centric gearboxes are derived from the robotic assembly industry where they run 100% duty cycle for months at a time. These are the most robust gearboxes ever applied to tracking antenna systems, providing years of maintenance-free service with backlash of less than 0.016 degrees. Your antenna will be pointed exactly where you intended.

**Servo Amplifiers** – State-of-the-art servo amplifiers are fully compensated and have comprehensive protection and HTAC monitoring. This conservative design philosophy leads to years of trouble free operation, even under heavy usage.

**Sealed Enclosures** – All pedestals and feeds are sealed with O-rings (not gaskets) and pressurized to eliminate any possibility of moisture ingress. Thermostatically controlled heaters provide an added measure of environmental immunity.

**Dehydrators** – Pressurizing dehydrators remove moisture from the air before pumping it into the sealed enclosures. Your pedestal will have a desert climate on the inside, even when installed in the tropics.

**Connectors** – All pedestals utilize MIL-DTL-38999 aerospace grade sealed connectors for outdoor connections. Your antenna will give years of consistent, dependable operation. No more "flaky" intermittent behavior.

**Slip Rings and Rotary Joints** – All pedestals come standard with multi-conductor slip rings and a 2-channel rotary joint for continuous 360 degree azimuth rotation. Naturally, these are also sealed against environmental contaminants.

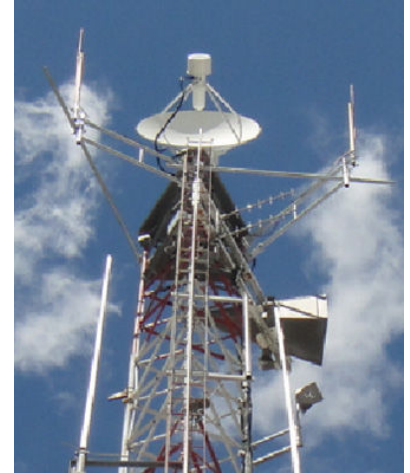

PD450 on Tower



PD750 Monopod Cassegrain



PD450 UHF

# Plano-centric Gearboxes

All pedestals systems are provided with plano-centric drives (supplied in sealed gearbox housings). Commonly used in robotics, such as pick-and-place machines, plano-centric drives have excellent performance features, superior to those of conventional gear transmissions.

- Excellent positioning accuracy
- High torque capacity
- Zero (less than 1 arc-min) backlash
- High single-stage reduction ratio
- High efficiency
- Minimal wear, long life
- High torsional stiffness
- Long life expectancy
- Maintenance free
- Zero adjustments

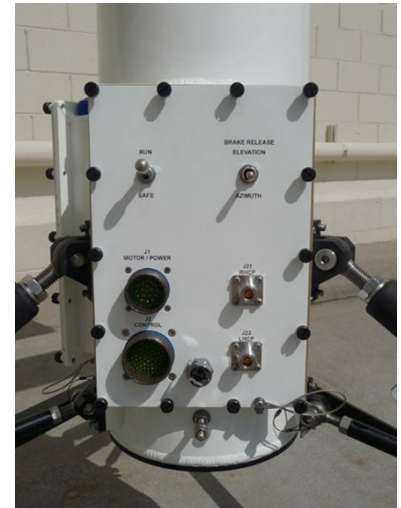

# Environmental Protection

Every HyperTrack system includes air dehydrators and thermo-electric temperature control with each system to prevent the ingress of moisture into the pedestal, the antenna feed, and the servo amplifier sub system.

- All environmental alarm indicators (temperature, pressure, humidity) displayed remotely on the HTAC control interface
- Compressor overrun and low pressure condition protection and alarms
- Dry air regulation to 0.4 psig
- Pressurization of moisture sensitive electronic enclosures and positioner interior spaces
- Thermostatically controlled heaters for environmental control located within the HyperTrack positioners and feeds

— Dehydrator —

<input checked="" type="checkbox"/>	Connected
<input checked="" type="checkbox"/>	System Status
<input type="checkbox"/>	Alarm
<input type="checkbox"/>	High Flow Alarm
<input type="checkbox"/>	High Outlet Pressure Alarm
<input type="checkbox"/>	Low Outlet Pressure Alarm
<input type="checkbox"/>	High Humidity Alarm
<input type="checkbox"/>	High Temperature Alarm
<input type="checkbox"/>	High Last Runtime Alarm
<input type="checkbox"/>	Maintenance Required
<input type="checkbox"/>	Compressor
<input type="checkbox"/>	Fan
<input type="checkbox"/>	Heater

Tank Pressure:	34.5	PSI
Outlet Pressure:	5.4	PSI
Flow Rate:	0.0	SCFD
Temperature:	75.8	°F
Humidity:	0.0	%

# HyperTrack Antenna Controller (HTAC) Features

**Supports HyperTrack Digital Control Interface** – Bypassing the analog AM and AGC interfaces entirely, the revolutionary HyperTrack Digital Control Interface from Quasonix brings you faster, more accurate tracking than you've ever seen before

**Ethernet Control Connections** – The HTAC communicates with the system via EtherCAT (Ethernet for Control Automation Technology) real-time, machine communication protocol for a more time accurate, deterministic connection

**Powerful, Intuitive User Interface** – Less clutter on the main screen for easier operation; All set up and advanced status reporting are on sub-menus and sub-windows

**Multiple Tracking Modes** – Accepts pointing data from remote customer slave sources; Server based local HTAC allows for slaving of one HyperTrack to another and enables tracking from user provided files of predicted or projected data

**Smaller 2U Form Factor** – “Headless” design minimizes rack space; 4.3 inch touchscreen for set up and network configuration

**More Detailed System Status Feedback** – Safety controller, dehydrator status, power health, position, velocity, motor current, track error, RSSI, dynamic bandwidth, and many others

**Comprehensive Diagnostics** – Comprehensive status and diagnostic information; Real-time scroll plots for Position, Velocity, and Current for each Axis; Real-time scroll plots for Tracking Error, AGC, and Tracking Loop Performance; Network accessible Oscilloscope View of Antenna AM, AGC, and DQM; Scope Snapshot Recorder for post-mission analysis; User configurable system status logger for post-mission analysis

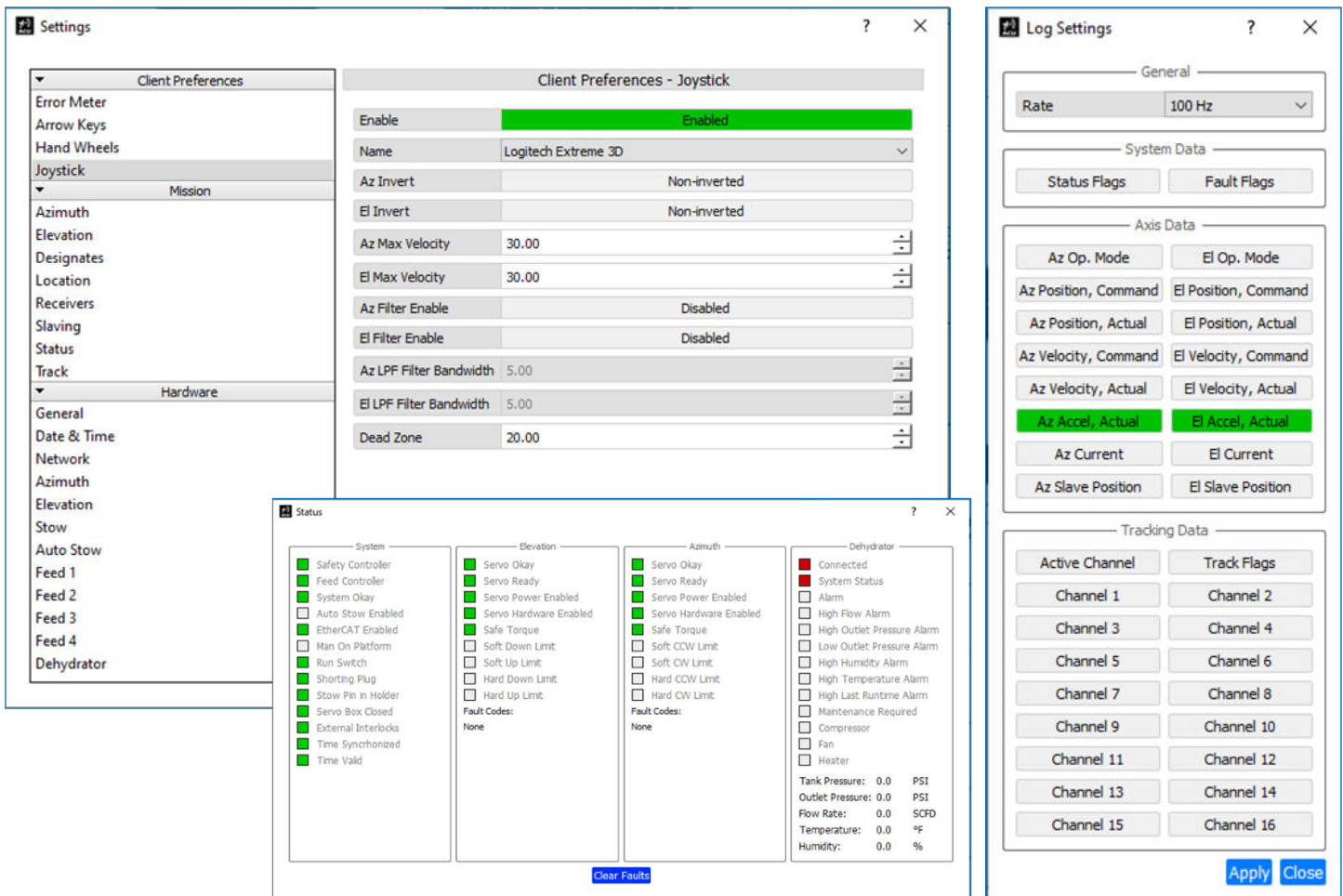

# HyperTrack Antenna Controller (HTAC) Interface

Quasonix combines a state-of-the-art FPGA based, real time antenna controller with a straightforward, touch screen configuration interface for setup. This enables the user to work from a remote display for configuring, monitoring, and controlling all missions. All status related to the pedestal and HTAC operations can be continuously broadcasted via a multicast port, allowing any computer on the network to gather all system information in one data log, time-stamped ASCII file.

- Touch screen user interface
- Back panel USB, ethernet, serial, and test ports
- Solid state storage memory
- Ethernet-based remote operation
- Comprehensive calibration tools
- Connections for up to 8 receivers



The screenshot displays the 'HyperTrack Client (Version 1.4.0-c9da3e3)' software interface. The top bar includes the Quasonix logo and a 'View: Standard' dropdown. The main interface is divided into several functional panels:

- Elevation:** A circular gauge showing 'Command' and 'Actual' values of 54.687 degrees. The velocity is 0.00. A 'Slave' indicator is visible at the bottom right.
- Tracking:** A circular plot with a green dot at the center. It shows 'Elevation' at -0.01 and 'Azimuth' at 0.00. A small angle of 1.3 degrees is also indicated.
- Azimuth:** A circular gauge showing 'Command' and 'Actual' values of 278.316 degrees. The velocity is 0.00. A 'Slave' indicator is visible at the bottom right.
- RSSI:** A control panel for Receiver Signal Strength Indication, including 'A. Rx Threshold' (4.0 dB), 'Auto Rx Off' button, and four receiver channels (1-LHCP, 2-RHCP, 3-Combiner, 4-V. Comb.) with their respective frequencies (5.2, 5.2, 7.6, 7.6 MHz).
- Mode Control:** A grid of buttons for 'Elevation' and 'Azimuth' with modes: Track, Acquire, Search, Slave, Manual (highlighted in green), and Standby. A 'Servo' button is located below the grid.
- Designates:** A table listing mission designates with their Elevation (El) and Azimuth (Az) values.
 

Designate	El	Az
	45.000	30.000
	48.222	216.048
	90.000	204.499
	7.288	281.881
- Input Controls:** Panels for 'Elevation Input Control' and 'Azimuth Input Control', each with 'HW Position', 'HW Velocity' (highlighted in green), and 'JS Velocity' options.

The bottom status bar shows 'System: IRAD PD450 User: admin' on the left and '09-14-2022 19:05:41 UTC' on the right.

Control the auto-tracking antenna with the remote user interface

# Antenna Feeds

**Environmentally Protected Feeds** – All Quasonix feeds are maintenance-free, using heating and dry-air pressurization to reduce moisture ingress for maximum life expectancy and ensuring consistent performance in any weather.

**Dual Polarizations for Both Receive and Transmit** – E-scan and Conscan feeds offer simultaneous left-hand and right-hand circular polarizations.

## Electronically Scanned Feeds

**Electronic Scanning for Highly Dynamic Targets** – Quasonix E-scan feeds sweep the beam by electronic means, allowing scan rates up to 2.0 kHz. These high scan rates can greatly mitigate the challenges inherent in tracking targets that impose high degrees of amplitude modulation on the transmitted signal (rotorcraft or spinning missiles, for example).

**3D-printed Waveguides** – Assure best possible low VSWR and low axial ratio across the band.

**Multiple Frequency Bands in a Single Feed** – E-scan feeds are available in multi-band configurations covering Lower L, Upper L, S, and C bands in a single feed; low-loss, high-selectivity cavity tuned filters for interference rejection.

**No spars required** – The SCM feed can support its subreflector without spars.

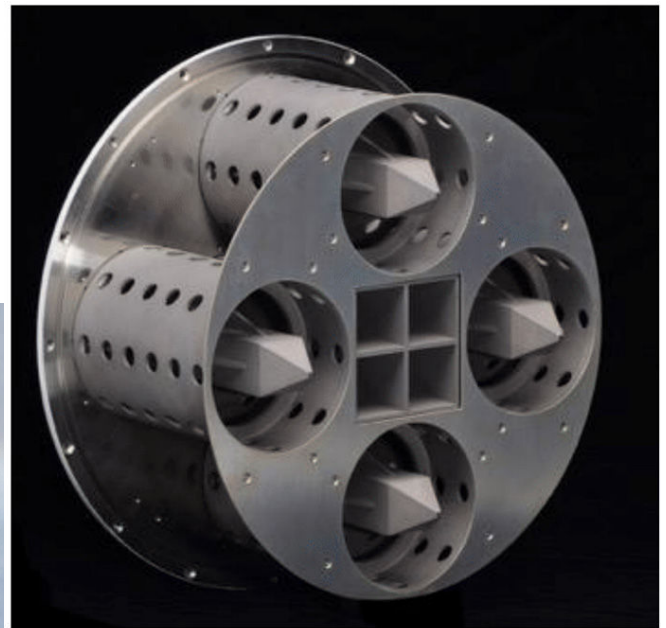

## Antenna Feeds (Continued)

### Conical Scanning Feeds

**Highest Possible G/T for Single-band Feeds** – Quasonix Conscan feeds integrate brushless, hollow-shaft DC motors with the most innovative waveguides in the industry to cast the smallest shadow on the reflector. In conjunction with the direct routing of the waveguides to the RF output connectors, this ensures that the complete system is delivering the highest-quality signal.

**High Reliability Conical Scanning** – Utilizing brushless, hollow-shaft DC motors with permanently sealed bearings, high-precision balancing, and pressurized enclosures, Quasonix Conscan feeds provide decades of trouble-free operation.

**Multiple Frequency Bands** – Conscan feeds are available in multi-band configurations covering Lower L, Upper L, S, and C bands in a dual feed; low-loss, high-selectivity cavity tuned filters for interference rejection.





# Telemetry Antenna Systems

**Target Simulator** – Each Quasonix antenna system includes the Target Simulator, whereby the motion of a virtual target is defined and controlled. This becomes an amazingly powerful tool when used in conjunction with the Ground Station Analyzer.

**Ground Station Analyzer** – Integral to HyperTrack, the breakthrough Ground Station Analyzer (GSA) generates an RF signal with the correct amplitude modulation (depth and phase) to match the motion of the virtual target. This RF signal is radiated from the subreflector to the feed. Unlike “test signal injection” schemes, where the AM signal is inserted somewhere downstream of the feed, the GSA exercises every single component in the RF path. No defect or failure can be overlooked.

**Engineered and Manufactured Entirely in the USA** – Quasonix has two facilities, both in the USA. Our transmitters and receivers are designed, built, tested, and supported from our headquarters in West Chester, Ohio. Our antenna division is anchored in Moorpark, California, but our Ohio facility provides both engineering and manufacturing support to our California team.

**Complete Telemetry System Integration** – Quasonix has already delivered thousands of transmitters, hundreds of receivers, and dozens of Receiver Analyzers (RF signal simulators) to the telemetry market, and our technical leadership is widely recognized.

The telemetry antenna systems are a seamless extension of this technical edge, and you can be assured that if one vendor – Quasonix – provides every RF component in the link, the overall system will operate smoothly and effectively.

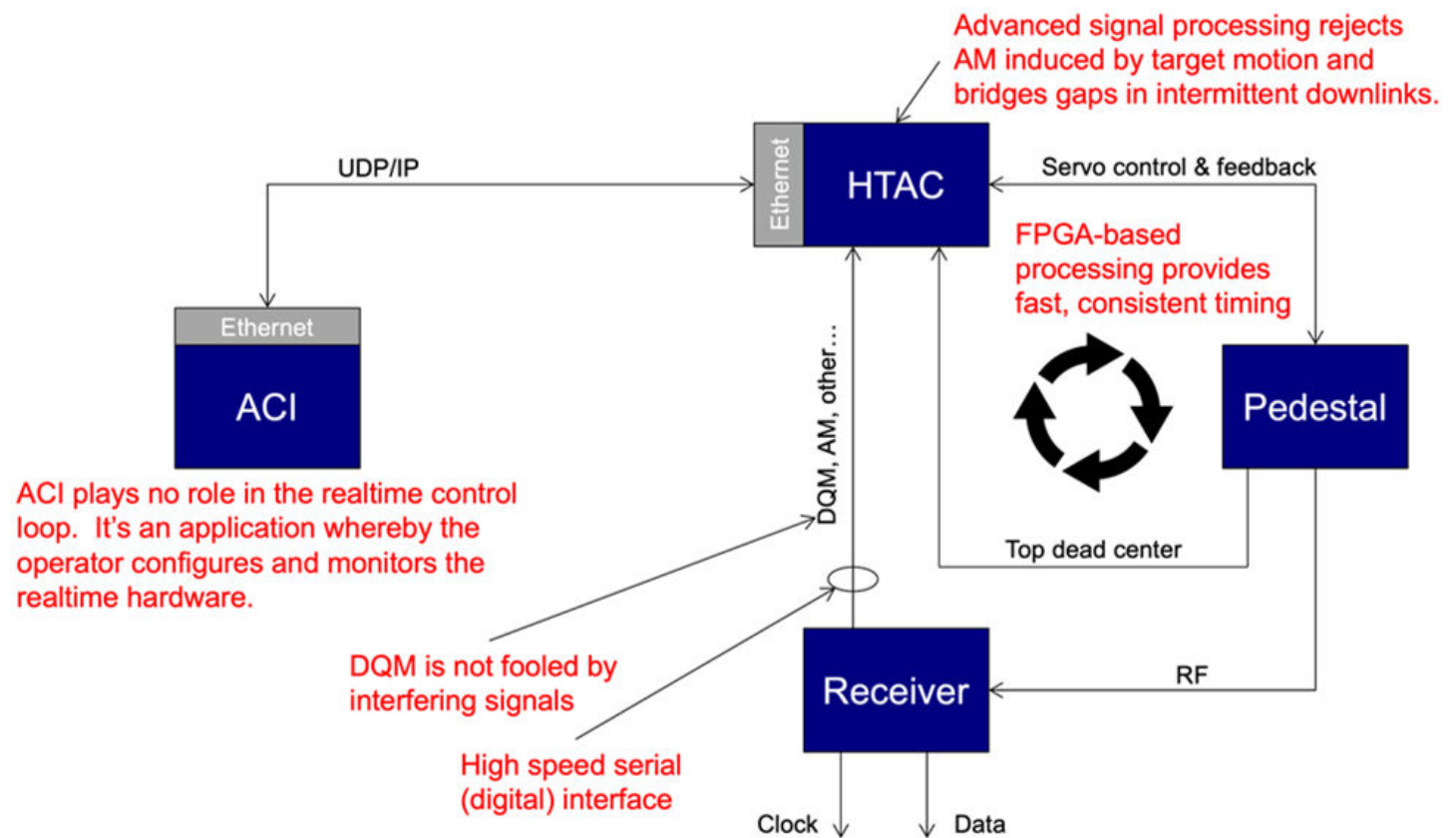
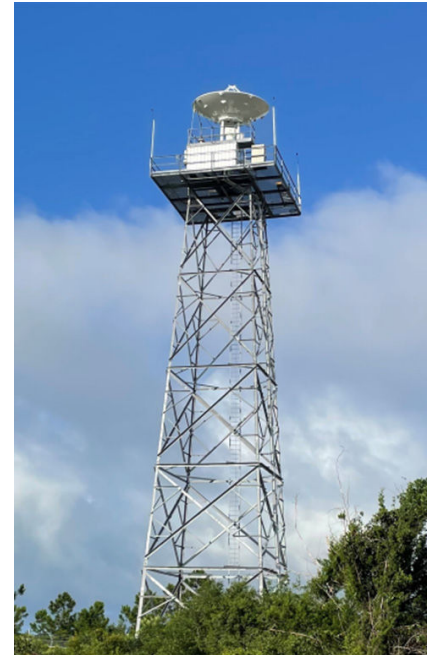

HyperTrack Functional Flow

# Better, Stronger, Faster

HyperTrack is going places, through innovative engineering that allows for greater size, mobility, and utility, while maintaining extended durability and jitter-free precision tracking.

System architecture is linear and scalable across the entire series of antenna models. The scalable architecture minimizes spare costs and training costs while maximizing flexibility and commonality.

Below are some ongoing HyperTrack product-line extensions driven by requests for solutions from the marketplace.

## PD500 8-foot (2.4-meter) Reflector on a Trailer



Digital Antenna - RF arrives, IP packets delivered

## PD300 4-foot (1.2-meter) System - Land or Mobile

The PD300 is a scaled-down version of our standard HyperTrack Model PD450. It supports customer requirement for smaller multifunction mobile or transportable 4-foot (1.2-meter) reflector assemblies. It shares the same architecture, precision, and quality as the entire family of Quasonix HyperTrack Antenna systems. The Mobile PD300 depicted here includes a 30-foot mast. This allows acquisition to be above obstructions for clean data collection.

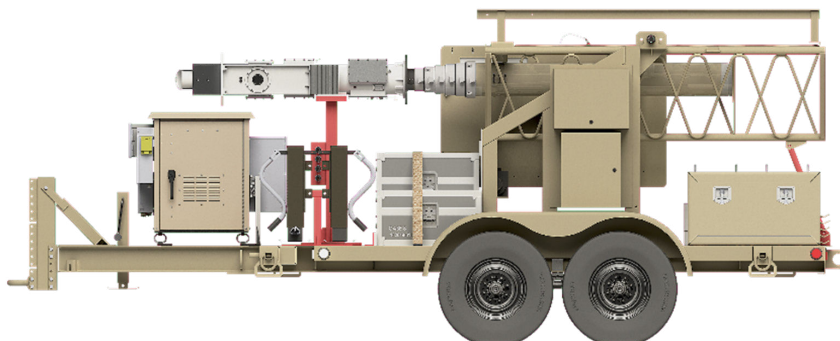

## Better, Stronger, Faster (Continued)

### ADAPT™ PD750 12-foot (3.7-meter) System with Automated Deployment

The Quasonix ADAPT PD750 auto-deployable antenna gives you our best-in-class HyperTrack data acquisition in a portable, large reflector size with fast and easy setup.



The ultimate in mission readiness anywhere in the world

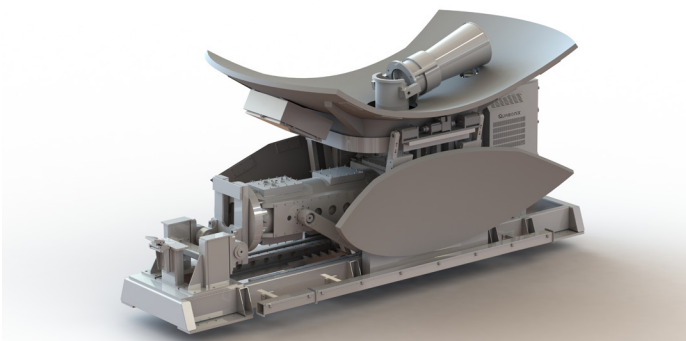

Stored configuration



Fully deployed

## Better, Stronger, Faster (Continued)

### PD900 24-foot (7.3-meter) System – Land or Mobile

The PD900 is modular antenna assembly that supports prime focus, Cassegrain and prime/Cassegrain configurations. Standard feed types include Monopod, Single Channel Monopulse (SCM), CONSCAN or combinations of types. As with the entire series of our positioners, the PD900 is built from known proven technology utilized in the robotics industry - applications requiring 24 hours, 7 days a week precision positioning with a 98% uptime requirement - far more demanding than duty cycles in our market.



The PD900 Mobile has been designed to be compliant with US road standards and US military air transport without modification. All Quasonix supplied equipment is stored on the trailer system and not on the tow vehicle. The mobile configuration allows the user the most flexibility in multipurpose use of the asset.



PD900 fixed system with a 24-foot composite radome



Modular design results in reduced costs via common spare parts, a common user interface, and common operator and maintenance training

## Better, Stronger, Faster (Continued)

PD900 24-foot (7.3-meter) System – Land or Mobile (Continued)



You can see the future from here

## Side-by-Side Comparison of Precision Drive Pedestals

	PD300	PD450	PD500	PD750	PD900
Antenna Capability	Up to 4 feet (1.2M)	Up to 6 feet (1.8M)	Up to 10 feet* (2.44M)	Up to 16 feet (5M)	Up to 24 feet (7.3M)
Typical Conscan Performance	4' / 1.2 Meter G/T - Beamwidth	6' / 1.8 Meter G/T - Beamwidth	8' / 2.44 Meter G/T - Beamwidth	16' / 5 Meter G/T - Beamwidth	23' / 7.3 Meter G/T - Beamwidth
1500 MHz	-0.5    11.2°	3.5    7.5°	6.3    5.5°	12.7    2.7°	14.5    2.2°
2300 MHz	3.0    7.3°	7.0    4.9°	9.8    3.6°	16.2    1.7°	18.0    1.4°
4400 MHz	5.5    4.0°	9.0    2.5°	11.0    1.9°	17.0    0.9°	21.5    0.65°
Compliance (radians/ft lb.)	1.75 x 10 <sup>-5</sup>	2.3 x 10 <sup>-5</sup>	2.0 x 10 <sup>-5</sup>	4.0 x 10 <sup>-7</sup>	2.0 x 10 <sup>-7</sup>
Pedestal Wgt	175 lbs	400 lbs	800 lbs	2400 lbs	3950 lbs
Wind Operating Gusting Survival	50 MPH 65 MPH 120 MPH	50 MPH 65 MPH 120 MPH	45 MPH -10 feet* 50 MPH - 8 feet 65 MPH 120 MPH	50 MPH 65 MPH 120 MPH	50 MPH 65 MPH 120 MPH
Power Requirements	1.5 KW 115/230 VAC 50-60 Hz, 1Ø	2.5 KW 115/230 VAC 50-60 Hz, 1Ø	3.0 KW 115/230 VAC 50-60 Hz, 1Ø	4.0 KW 208/400 VAC 50-60 Hz, 3Ø	5.0 KW 208/400 VAC 50-60 Hz, 3Ø
Torque	Cont-125 ft-lbs Peak-250 ft-lbs	Cont-235 ft-lbs Peak-400 ft-lbs	Cont-900 ft-lbs Peak-1800 ft-lbs	Cont-3600 ft-lbs Peak-7200 ft-lbs	Cont-5800 ft-lbs Peak-12000 ft-lbs
Velocity	30°/sec	30°/sec	30°/sec	20°/sec	15°/sec
Acceleration	40°/sec <sup>2</sup>	40°/sec <sup>2</sup>	40°/sec <sup>2</sup>	20°/sec <sup>2</sup>	20°/sec <sup>2</sup>
Backlash	0.016 degrees typical				
VSWR	2:0:1 maximum				
Axial Ratio	< 2.0 dB maximum				
Polarization	Simultaneous dual or single, all variants of Circular or Linear polarization				
Travel	Azimuth: Continuous, Optional up to + 420° with pre-limits Elevation: -8° to +188° (Software), -10° to +190° (Electrical), -12° to +192° (Mechanical)				
Environmental					
Operating Temperature	-30°C to +52°C				
Storage Temperature	-54°C to +71°C				
Relative Humidity	Up to 100%, including condensation				
Rain	Up to 4 inches per hour				
Ice	1/2 inch, Radial				

# HyperTrack Configuration

Primary Configuration			
Pedestal Size	300 450 500 750 900	Reflector Format	P: Conscan sectional S: Conscan solid C: Spar-mount Cassegrain M: Monopod Cassegrain
Reflector Size	03: 3 ft (1.0 m) 04: 4 ft (1.2 m) 06: 6 ft (1.8 m) 08: 8 ft (2.4 m) 10: 10 ft (3.0 m) 12: 12 ft (3.7m) 14: 14 ft (4.3 m) 16: 16 ft (5.0 m) 20: 20 ft (6.1 m) 24: 24 ft (7.3 m)	Slip Ring/Cable Wrap	CW: Cable wrap S2: Slip ring / 2-channel rotary joint
		Feed Type	C: Conscan auto-tracking E: Escan auto-tracking N: Non-tracking

Frequency Range				
Band Code ID*	Lower L 1435.0 MHz to 1535.0 MHz	S 2200.0 MHz to 2290.0 MHz; 2365.0 MHz to 2395.0 MHz	USC 4400.0 MHz to 5150.0 MHz	Euro C 4400.0 MHz to 5250.0 MHz
C			✓	
F		✓		✓
L	✓			
M	✓	✓		
Q	✓	✓	✓	
S		✓		
V	✓			✓

\* Additional frequency ranges and combinations available. Contact Quasonix for more information.

## Options

AS: Auto Stow  
 CA: Ethernet-based HD Camera, 1080p 30 fps, h.264.  
 Hardware h.264 to HDMI decoder and display included  
 FC: Fiber Optic Control Connections  
 FR: Fiber Optic RF  
 GP: Differential GPS; Position and Heading  
 GY: MEMS IMU; Position, Heading and Motion Compensation

PS: Pedestal Spacer  
 RB: Reinforced Backup Structure  
 SF1: Site-Specific Feed Filtering  
 SF2: Site-Specific Feed Filtering  
 TR: Tripod  
 TX: Uplink Transmit Capable

# HyperTrack Antenna Part Numbering Example

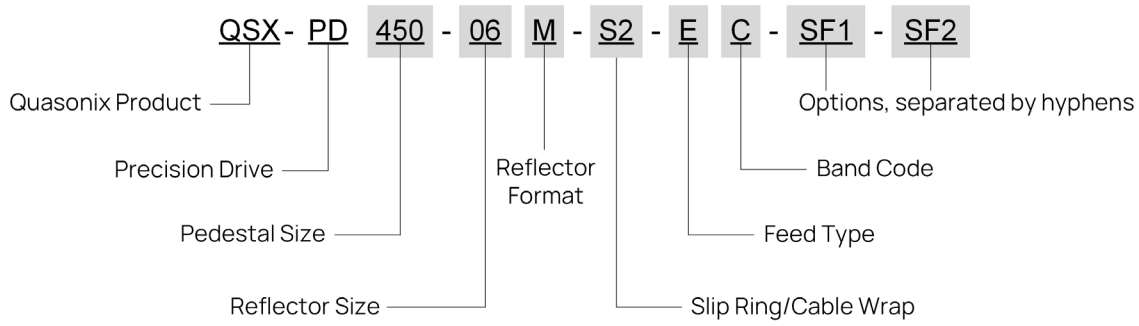

Proof that you CAN take it with you

**QUASONIX**

All Quasonix products are under U.S. Dept. of Commerce jurisdiction. Antenna products are categorized as 5A991.  
ISO 9001:2015 Certified | Specifications subject to change without notice.

6025 Schumacher Park Drive West Chester, OH 45069 | 1-513-942-1287 | [www.quasonix.com](http://www.quasonix.com)